



## VS7 Detector Set

Sensitive, fast MWIR set for <3.5 to 6+ microns with user selectable DC or AC coupling, user selectable upper frequency 1.5MHz, 15MHz or 200MHz, and variable gain.

- PVI-4TE-6-1x1
- PIP-DC-200M-F-M8
- PTCC-01-BAS

## Photovoltaic detectors optically immersed PVI

**PVI series** features room temperature and TE cooled IR photovoltaic detectors, optically immersed (achieved by using high refractive index micro lenses) in order to improve performance of the devices, different acceptance angle and saturation level. The devices are optimized for the maximum performance at  $\lambda_{opt}$ . Cut-on wavelength can be optimized upon request. Reverse bias may significantly increase speed of response and dynamic range. It results also in improved performance at high frequencies, but 1/f noise that appears in biased devices may reduce performance at low frequencies. Highest performance and stability are achieved by application of variable gap HgCdTe semiconductor, optimized doping and sophisticated surface processing.



Detector type	Cooling, operating temperature $T [K]$	Optimal wavelength <sup>*)</sup> $\lambda_{opt} [\mu m]$	Detectivity <sup>**)</sup> $D^* \left[ \frac{cm \cdot \sqrt{Hz}}{W} \right]$		Current responsivity $R_i \left[ \frac{A}{W} \right]$	Time constant $\tau [ns]$	Resistance optical area product $R \cdot A [\Omega \cdot cm^2]$	Acceptance angle $\varnothing [^\circ]_{\pm 2\sigma}$	Optical area <sup>***)</sup> $[mm \times mm]$	Package	Window <sup>****)</sup>
			@ $\lambda_{peak}$	@ $\lambda_{opt}$							
PVI	uncooled, ~300	3	$\geq 5.0 \times 10^{10}$	$\geq 5.0 \times 10^{10}$	$\geq 0.5$	$\leq 350$	$\geq 100$	~36, 1.62	0.5x0.5 1x1	BNC, TO39	no window
		3.4	$\geq 5.0 \times 10^{10}$	$\geq 4.5 \times 10^{10}$	$\geq 0.8$	$\leq 260$	$\geq 50$				
		4	$\geq 3.0 \times 10^{10}$	$\geq 2.0 \times 10^{10}$	$\geq 1$	$\leq 150$	$\geq 6$				
		5	$\geq 1.5 \times 10^{10}$	$\geq 9.0 \times 10^9$	$\geq 1$	$\leq 120$	$\geq 1$				
		6	$\geq 8.0 \times 10^9$	$\geq 4.0 \times 10^9$	$\geq 1$	$\leq 80$	$\geq 0.2$				
	two-stage TE-cooled (2TE), ~230	3	$\geq 8.0 \times 10^{11}$	$\geq 5.5 \times 10^{11}$	$\geq 0.5$	$\leq 280$	$\geq 15000$		0.5x0.5 1x1	TO8, TO66	wedged Al <sub>2</sub> O <sub>3</sub>
		3.4	$\geq 6.0 \times 10^{11}$	$\geq 3.0 \times 10^{11}$	$\geq 0.8$	$\leq 200$	$\geq 300$				
		4	$\geq 3.0 \times 10^{11}$	$\geq 2.0 \times 10^{11}$	$\geq 1.0$	$\leq 100$	$\geq 200$				
		5	$\geq 1.0 \times 10^{11}$	$\geq 6.0 \times 10^{10}$	$\geq 1.3$	$\leq 80$	$\geq 10$				
		6	$\geq 5.0 \times 10^{10}$	$\geq 2.0 \times 10^{10}$	$\geq 1.5$	$\leq 50$	$\geq 2$				
		8	$\geq 4.0 \times 10^9$	$\geq 2.0 \times 10^9$	$\geq 0.8$	$\leq 30$ $\leq 45$	$\geq 0.02$				
	three-stage TE-cooled (3TE), ~210	3	$\geq 9.0 \times 10^{11}$	$\geq 7.0 \times 10^{11}$	$\geq 0.5$	$\leq 280$	$\geq 24000$		0.5x0.5 1x1	TO8, TO66	wedged Al <sub>2</sub> O <sub>3</sub>
		3.4	$\geq 7.0 \times 10^{11}$	$\geq 5.0 \times 10^{11}$	$\geq 0.8$	$\leq 200$	$\geq 1500$				
		4	$\geq 5.0 \times 10^{11}$	$\geq 3.0 \times 10^{11}$	$\geq 1.0$	$\leq 100$	$\geq 600$				
		5	$\geq 1.0 \times 10^{11}$	$\geq 8.0 \times 10^{10}$	$\geq 1.3$	$\leq 80$	$\geq 30$				
		6	$\geq 6.0 \times 10^{10}$	$\geq 3.0 \times 10^{10}$	$\geq 1.5$	$\leq 50$	$\geq 2.5$				
		8	$\geq 5.0 \times 10^9$	$\geq 3.0 \times 10^9$	$\geq 1.0$	$\leq 30$ $\leq 45$	$\geq 0.04$				
	four-stage TE-cooled (4TE), ~195	3	$\geq 1.0 \times 10^{12}$	$\geq 8.0 \times 10^{11}$	$\geq 0.5$	$\leq 280$	$\geq 30000$		0.5x0.5 1x1	TO8, TO66	wedged Al <sub>2</sub> O <sub>3</sub>
		3.4	$\geq 8.0 \times 10^{11}$	$\geq 7.0 \times 10^{11}$	$\geq 0.8$	$\leq 200$	$\geq 2000$				
		4	$\geq 6.0 \times 10^{11}$	$\geq 4.0 \times 10^{11}$	$\geq 1.0$	$\leq 100$	$\geq 800$				
		5	$\geq 3.0 \times 10^{11}$	$\geq 1.0 \times 10^{11}$	$\geq 1.3$	$\leq 80$	$\geq 40$				
		6	$\geq 6.0 \times 10^{10}$	$\geq 4.0 \times 10^{10}$	$\geq 1.5$	$\leq 50$	$\geq 3$				
		8	$\geq 5.0 \times 10^9$	$\geq 4.0 \times 10^9$	$\geq 1.5$	$\leq 30$ $\leq 45$	$\geq 0.06$				
		10.6	$\geq 4.0 \times 10^9$	$\geq 2.0 \times 10^9$	$\geq 0.7$	$\leq 10$	$\geq 0.05$				
			$\geq 0.5$	$\leq 25$							

<sup>\*)</sup> Other optimal wavelengths available upon request.

<sup>\*\*)</sup> Data sheet states minimum guaranteed D\* values for each detector model. Higher performance detectors can be provided upon request.

<sup>\*\*\*)</sup> Other optical areas available upon request.

<sup>\*\*\*\*)</sup> Other windows available upon request.

<sup>1)</sup> Optical area available only for uncooled detectors

# Spectral characteristics<sup>\*)</sup>

PVI

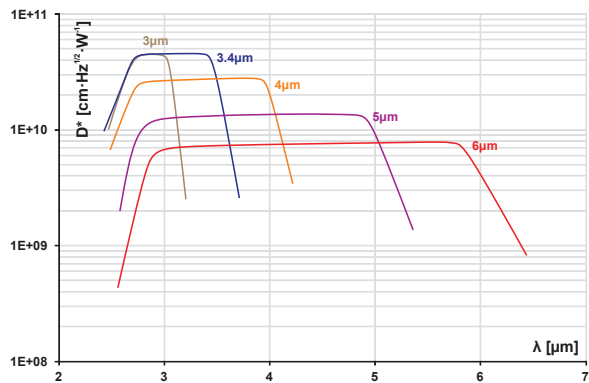

PVI-2TE

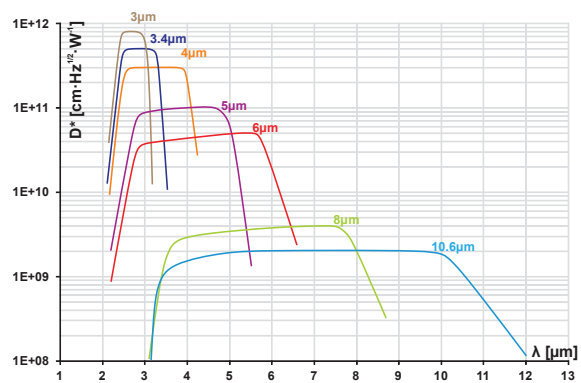

PVI-3TE

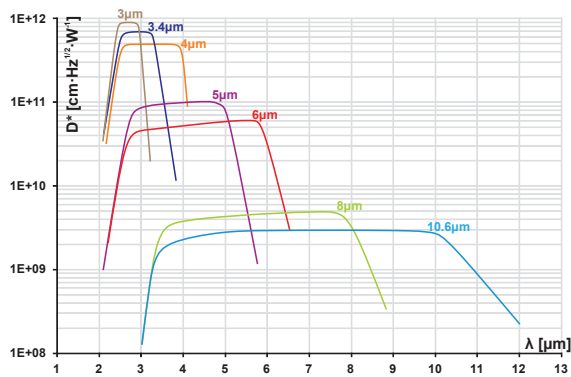

PVI-4TE

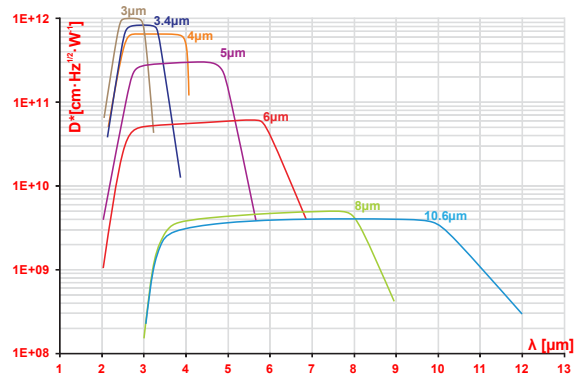

<sup>\*)</sup>Example of  $D^*$  vs wavelength  $\lambda$  for HgCdTe detectors. Spectral characteristics of individual detectors may vary from those shown on the chart.

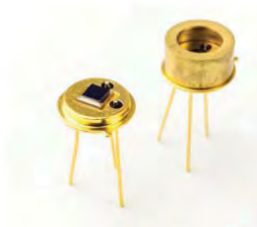

## PIP preamplifier



3

PIP is the programmable “smart” preamplifier. Due to the modern internal configuration, it offers extreme flexibility combined with superior signal parameters and high reliability. Included voltage monitor allows user to check the working conditions (supply voltages, detector bias voltage, first and last stage output voltage offset etc.)

- User may also immediately change the gain, coupling (AC/DC), optimize the first stage transimpedance (in terms of input noise and overall bandwidth), reduce the bandwidth down to 1.5 MHz (for suppressing wideband noise and convenient weak signal observation), and also manually or automatically suppress the voltage offset.
- The optimized parameters are immediately stored into the internal EEPROM memory and automatically loaded after the power is on.
- Reset to the factory settings is always available, and following the manual, the operation and manipulation is both: easy and safe.
- In some cases, detector biasing condition may be adjusted, however, for detector safety this function is blocked in factory by default.
- For proper operation PTCC-01 TEC controller is required.

### Code description

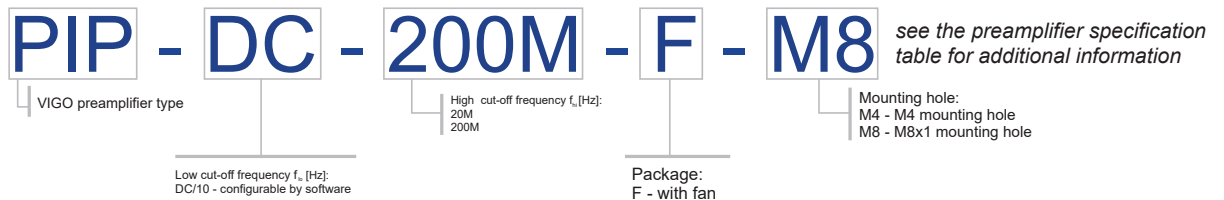

### Dimensions [mm]

**VS7 selectable bandwidths: 1.5MHz, 15 MHz, 200 MHz**

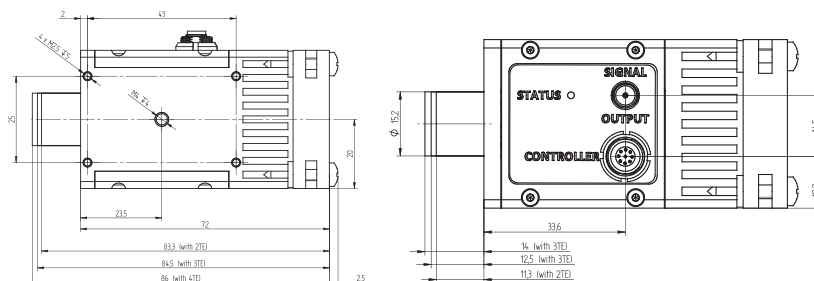

### Power supply and TEC control connector - LEMO connector female

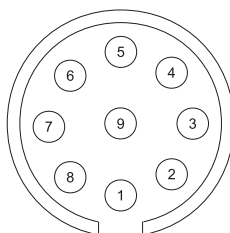

Pin number	Symbol	Function
1	FAN+	FAN (+)
2	TH2	thermistor output (2)
3	TEC-	TEC supply input (-)
4	-V <sub>sup</sub>	power supply input (-)
5	GND	power ground
6	+V <sub>sup</sub>	power supply input (+)
7	TEC+	TEC supply input (+)
8	TH1	thermistor output (1)
9	DATA	data pin



Preamplifier type	Main feature	Detector package	Detector type	Detector cooling	Radiator, cooling, TEC controlling	Input noise voltage density	Input noise current density	Low cut-off frequency
						$e_n \left[ \frac{nV}{\sqrt{Hz}} \right]$	$i_n \left[ \frac{pA}{\sqrt{Hz}} \right]$	$f_{lo} [Hz]$
VIP	standalone	BNC	PV, PVI, PVM, PVMI	uncooled	not needed	0.97 – 8.0 <sup>1)</sup>	0.02 – 3.5 <sup>1)</sup>	DC, 10, 100, 1k, 10k
μIP	micro-size	TO39	PC, PCI, PV, PVI, PVM, PVMI	uncooled	not needed	0.97 – 8.0 <sup>1)</sup>	0.02 – 3.5 <sup>1)</sup>	DC, 10, 100, 1k, 10k
QIP	four-channel	TO8	PCQ, PVQ, PVMQ	uncooled	on board radiator and TEC controller, fan	0.97 – 8.0 <sup>1)</sup>	0.02 – 3.5 <sup>1)</sup>	DC, 10, 100, 1k, 10k
SIP	ultra-small, OEM	TO39 TO8	PC, PCI, PV, PVI, PVM, PVMI	uncooled 2TE, 3TE, 4TE	external heatsink needed	0.97 – 8.0 <sup>1)</sup>	0.02 – 3.5 <sup>1)</sup>	DC, 10, 100, 1k, 10k
FIP	very fast	TO8	PC, PCI, PV, PVI, PVM, PVMI	2TE, 3TE, 4TE	on board radiator, fan	1.1	5.0	1k, 10k
MIP	standard	TO8	PC, PCI, PV, PVI, PVM, PVMI	2TE, 3TE, 4TE	on board radiator, fan	0.97 – 8.0 <sup>1)</sup>	0.02 – 3.5 <sup>1)</sup>	DC, 10, 100, 1k, 10k
PIP	programmable	TO8	PC, PCI, PV, PVI, PVM, PVMI	2TE, 3TE, 4TE	on board radiator, fan	0.95	4.5 7.0	DC/10
AIP	on board TEC controller	TO8	PC, PCI, PV, PVI, PVM, PVMI	2TE, 3TE, 4TE	on board radiator and TEC controller, fan	0.97 – 8.0 <sup>1)</sup>	0.02 – 3.5 <sup>1)</sup>	DC, 10, 100, 1k, 10k

- 1) noise measurement frequency  $f_0 = 10kHz$
- 2) first stage transimpedance =  $1k\Omega$
- 3) first stage transimpedance =  $5k\Omega$
- 4) transimpedance range  $\frac{K_{imax}}{K_{imin}}$  up to 5 (dependent on  $f_{hi}$ )
- 5)  $f_{hi} \leq 1MHz$ , load resistance  $R_L = 1M\Omega$
- 6)  $f_{hi} > 1MHz$ , load resistance  $R_L = 50M\Omega$

High cut-off frequency	Transimpedance	Output impedance	Output voltage swing	Output voltage offset	Power supply voltage	Power supply current	Supply connector	Signal output
$f_{hi}[Hz]$	$K_i \left[ \frac{V}{A} \right]$	$R_{out}[\Omega]$	$V_{out}[V]$	$V_{off}[mV]$	$V_{sup}[V]$	$I_{sup}[mA]$		
100k, 300k, 1M, 5M, 10M, 20M	fixed up to $1.0 \times 10^5$	50	$\pm 10^{5j}$ $\pm 2^{6j}$	max $\pm 20^{9j}$	$\pm 15^{12j}$ $\pm 9^{13j}$	max $\pm 25$	DB9	BNC
100k, 300k, 1M, 5M, 10M, 100M, 200M	fixed up to $1.0 \times 10^5$	50	$\pm 2^{5j}$ $\pm 1^{6j}$	max $\pm 20^{9j}$	$\pm 9$	max $\pm 50$	MOLEX1x3	MMCX
100k, 300k, 1M, 5M, 10M, 100M	fixed up to $2.0 \times 10^5$	50	$\pm 2^{5j}$ $\pm 1^{6j}$	max $\pm 20^{9j}$	+5	max $\pm 50$	DC 2.1/5.5	4xMMCX
100k, 300k, 1M, 5M, 10M, 100M, 250M	tunable <sup>4j</sup> up to $1.0 \times 10^5$	50	$\pm 10^{5j}$ $\pm 1^{6j}$	max $\pm 20^{9j}$	$\pm 15^{12j}$ $\pm 9^{13j}$	max $\pm 50$	AMP2x4	MMCX
<b>1G</b>	fixed up to $8.5 \times 10^3$	50	$\pm 1$	-	+12/-5	+100 -50	LEMO	SMA ( DC monitor as an option)
100k, 300k, 1M, 5M, 10M, 100M, 250M	fixed up to $2.0 \times 10^5$	50	$\pm 10^{5j}$ $\pm 2^{7j}$ $\pm 1^{8j}$	max $\pm 20^{9j}$	$\pm 15^{12j}$ $\pm 9^{13j}$	max $\pm 50$	LEMO	SMA
150k/1.5M/20M 1.5M/15M/200M	digitally adjustable 500 – 30k <sup>2j</sup> 2.5k – 150k <sup>3j</sup>	50	$\pm 1$	max $\pm 20^9$ (DC) max $\pm 10$ (AC)	$\pm 9$	typ $\pm 80$ max $\pm 100$	LEMO	SMA
100k, 300k, 1M, 5M, 10M, 100M, 250M	fixed up to $2.0 \times 10^5$	50	$\pm 2^{5j}$ $\pm 1^{6j}$	max $\pm 20^{9j}$	+5 <sup>10j</sup> +12 <sup>11j</sup>	max $\pm 50$	DC 2.1/5.5	2xSMA ( DC monitor as an option)

7)  $1MHz < f_{hi} \leq 20MHz$ , load resistance  $R_L=1M\Omega$

8)  $20MHz < f_{hi} \leq 250MHz$ , load resistance  $R_L=50M\Omega$

9) Measured with equivalent resistor at the input instead of the detector. It's to avoid the environmental thermal radiation's impact

10) with uncooled, 2TE and 3TE detectors

11) with 4TE detectors

12)  $f_{hi} \leq 1MHz$

13)  $f_{hi} > 1MHz$

## PTCC-01 – Programmable “smart” TEC controller



PTCC-01 is the programmable, precision, low noise, thermoelectric cooler controller, intended to operate with VIGO IR detection modules. It is compatible with both classic (MIP, SIP, FIP) and new, programmable PIP preamplifiers.

### Available options:

#### PTCC-01-OEM

- TE C controller with built-in power supply, without housing
- configurable by PC software
- status LED indicator and status/data connector

#### PTCC-01-BAS

- TEC controller with built-in power supply, encapsulated in a small package
- configurable by PC software
- status LED indicator

#### PTCC-01-ADV

- TEC controller with built-in power supply, encapsulated in a small package
- configurable by built-in function keys or PC software
- user interface: LCD and buttons

Specification

Parameter	Value
Temperature stability [K]	$\pm 0.01$ ( $T_{det}=233K$ (-40°C), $T_{det}=0.1K$ )
Temperature readout stability [mK]	max 1 ( $T_{det}=233K$ (-60°C), $T_{det}=0.1K$ )
Detector temperature settling time [s]	25 ( $T_{det}=233K$ (-40°C), $T_{det}=0.1K$ ) 45 ( $T_{det}=233K$ (-60°C), $T_{det}=0.1K$ ) 60 ( $T_{det}=233K$ (-80°C), $T_{det}=0.1K$ )
Maximum TEC current [A]	1.2 (2TE) 0.45 (3TE) 0.45 (4TE)
Output voltage range [V]	min 3, max 14.5
Output current of the built-in power supply [mA]	$\pm 200$ (output voltage: 3...14.5V)
Power supply voltage $V_{sup}$ [V]	min 9, max 16 (wider range available upon request)
Power supply current $I_{sup}$ [mA]	500 ( $I_{TEC}=0.45A$ , $U_{TEC}=7.5V$ )
Series resistance of the connecting cable [mΩ]	1000 (total resistance of the wires supplying TEC element)
Storage temperature [°C]	from -20 to +70
Ambient temperature [°C]	from +5 to +45
Relative humidity [%]	from 10 to 90 (from +5°C to +35°C) from 10 to 50 (> +35°C)



Code description

# PTCC-01-BAS

VIGO thermoelectric cooler controller

Version:  
 OEM - without package  
 BAS - Basic - with package  
 ADV - Advanced - with package, function buttons and LCD

Dimensions [mm]

PTCC-01-OEM

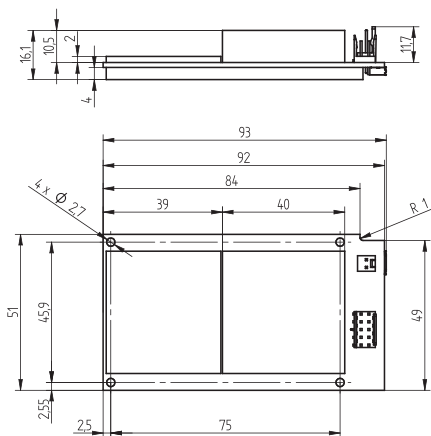

PTCC-01-BAS

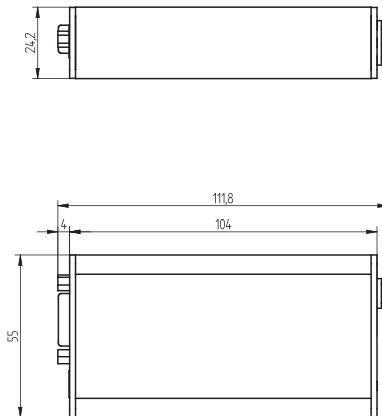

PTCC-01-ADV

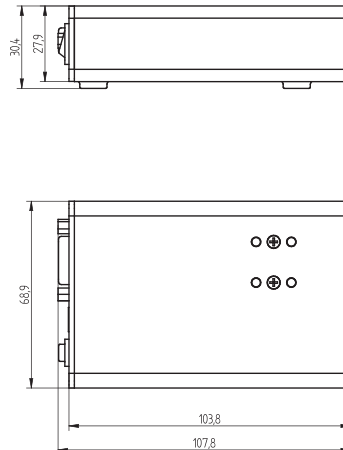



Power supply and control connector (PTCC-01-BAS and PTCC-01-ADV) - DB9 connector female

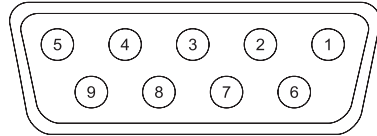

Pin number	Symbol	Function
1	TEC+	TEC supply output (+)
2	TEC-	TEC supply output (-)
3	GND	power ground
4	TH1	thermistor input (1)
5	TH2	thermistor input (2)
6	-V <sub>sup</sub>	power supply output (-)
7	+5V	FAN and programmable preamp internal logic auxiliary supply
8	DATA	bidirectional data port
9	+V <sub>sup</sub>	power supply output (+)
metal cover	GND-SH	shield



Power supply connector (PTCC-01-OEM) - KK2 connector male



Pin number	Symbol	Function
1	TECC+	TEC controller supply input (+)
2	TECC GND	TEC controller power ground

Control connector (PTCC-01-OEM) - DUBOX2x5 connector male



Pin number	Symbol	Function
1	TEC+	TEC supply output (+)
2	TEC-	TEC supply output (-)
3	GND	power ground
4	TH1	thermistor input (1)
5	TH2	thermistor input (2)
6	-V <sub>sup</sub>	tower supply output (-)
7	+5V	FAN and PIP preamp internal logic auxiliary supply
8	DATA	bidirectional data port
9	+V <sub>sup</sub>	power supply output (+)
10	GND-SH	shield

Status/DATA connector (PTCC-01-OEM) - Pin Header 1x7

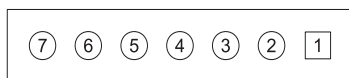

Pin number	Symbol	Function
1	ERR - LED	error indicator
2	LOCK - LED	temperature control loop lock indicator
3	SUP - LED	module power supply on indicator
4	3.3 V	auxiliary supply
5	TXD	transmitted data (RS-232)
6	GND	common (signal) ground (RS-232)
7	RXD	received data (RS-232)