

Room Temperature Tunable Quantum Cascade IR Lasers



Readily available CW and Pulsed:

- **Single Mode DFBs** – devices between 4.2 – 16.6 μm
- **Fabry-Perot** – suitable for external cavity use including devices EC-tunable over 300cm^{-1}
- **Built to order:** $\sim 4 - >200 \mu\text{m}$



Boston Electronics are exclusive North American Technical Sales Agents for Tunable Infrared Quantum Cascade Lasers from Alpes Lasers SA of Switzerland. Alpes Lasers was the first QCL company in the world and offers a variety of QCLs which differ in semiconductor architecture and intended use. This sheet is intended to help you understand the available options and make your choice quicker and easier.

Spectroscopy Grade, Tunable	DFBs	Extremely narrow linewidths tune over a narrow spectral range with high resolution (usually $< 1 \text{ cm}^{-1}$) with milliwatts of power for Beer's Law measurements.
	Extended tuning range DFBs	-XT and -ET series devices with embedded chip features to allow rapid tuning over $> 5 \text{ cm}^{-1}$ or wider - tuning (to $> 2\%$ of center wavelength)
	External Cavities	Extended tuning up to 300 cm^{-1} with linewidths and of 1 cm^{-1} and pulsed operation at mW average power levels
	Frequency Combs	Simultaneous measurement of high-resolution spectra over $> 50 \text{ cm}^{-1}$ enabled by this concept
Compact IR Sources at arbitrary wavelengths	Fabry Perots	Emission bands (gain profiles) from 50 to $> 300 \text{ cm}^{-1}$. Power levels from 10s of mW to $> 1.5\text{W}$ average or $> 20\text{W}$ peak. Applications include chips for external cavities, IR communications and IRCM.

Alpes #sb9 at different temps with different drive voltages

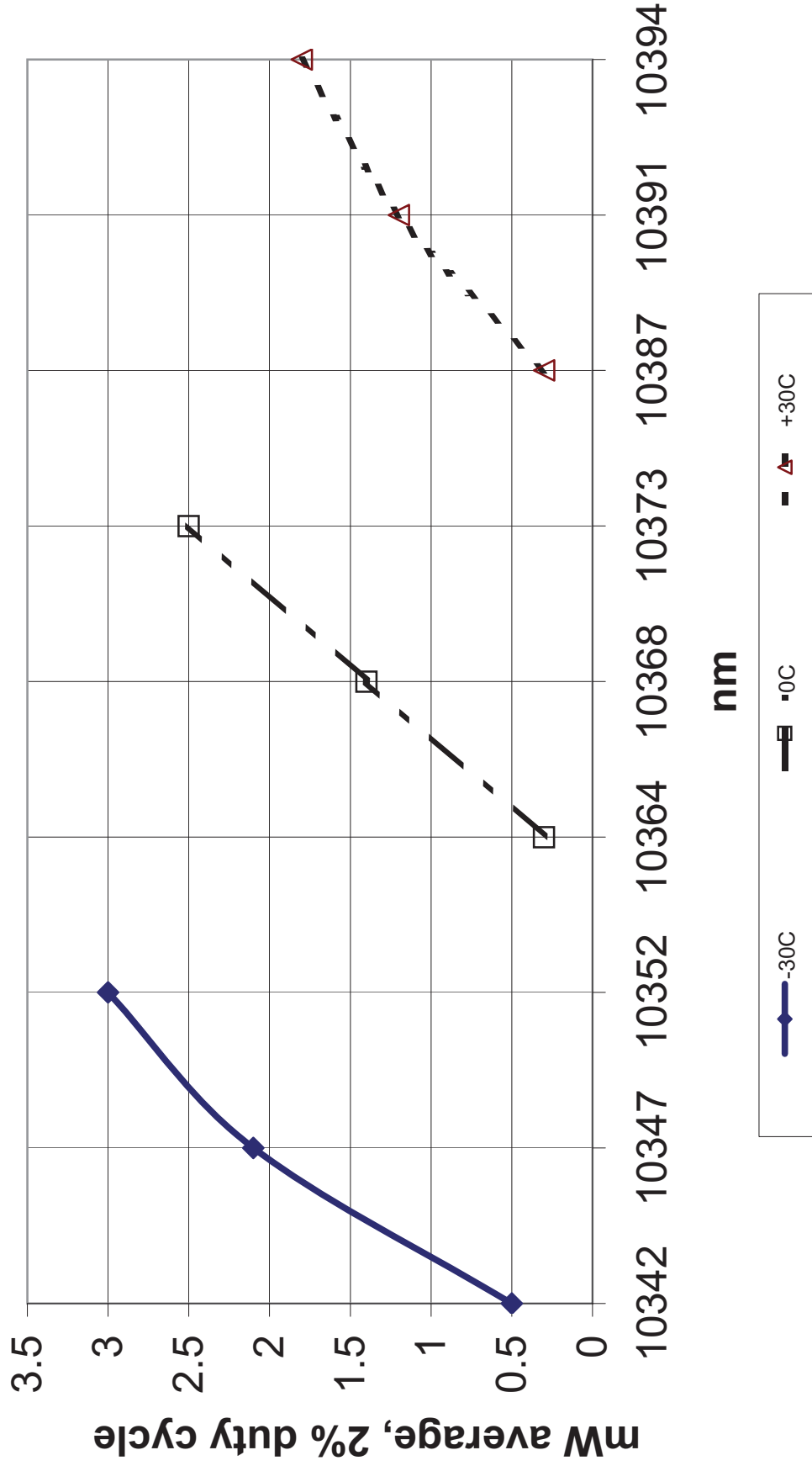

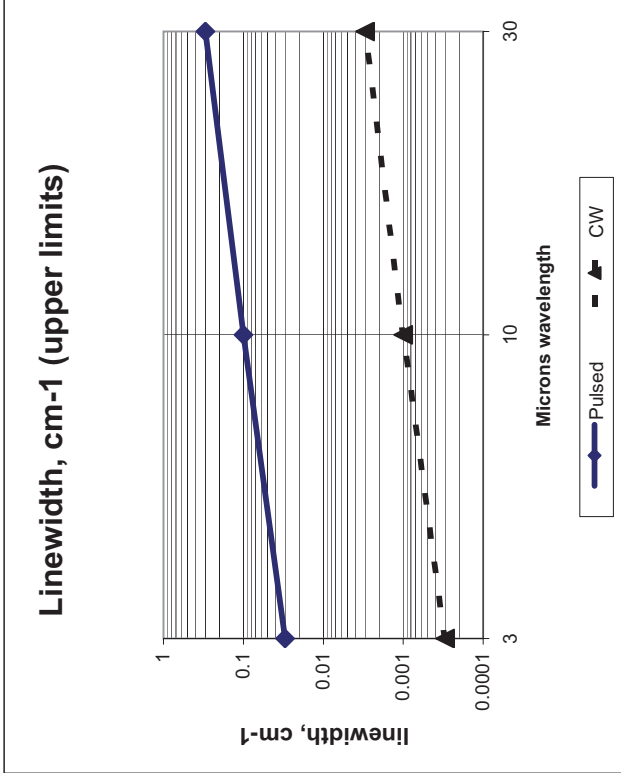
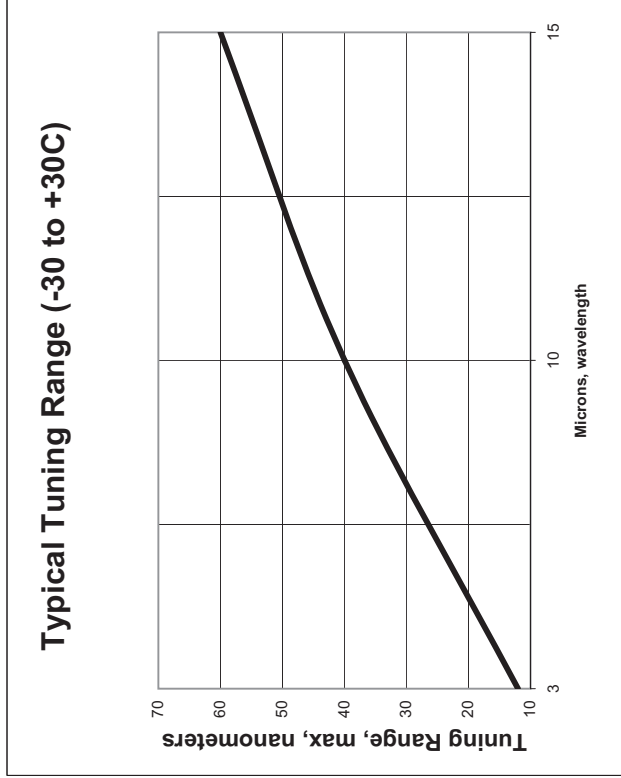
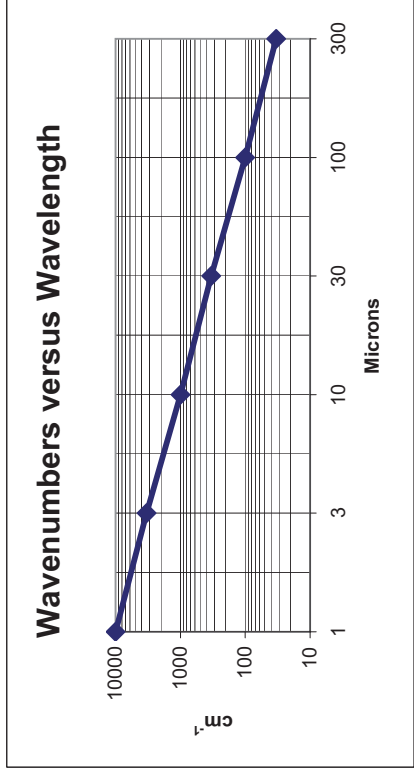
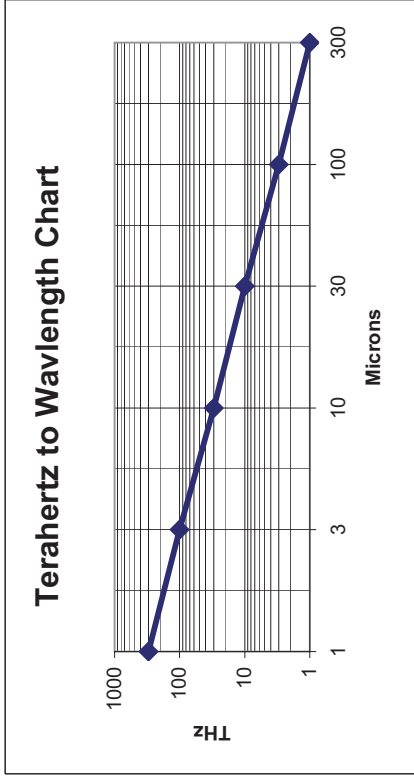

Some useful numbers and some typical results.

CW Single Mode Laser

Alpes Lasers flagship product, the Continuous Wave, Distributed Feedback Grating Quantum Cascade Laser has been the most versatile mid-IR light source since 2005. These lasers are able to emit a single wavelength at a time. They can be tuned within a range that can reach up to 4 cm^{-1} ; there exists a variety of modulation schemes which can be used for different purposes. These lasers are available as chips-on-submount or packaged in HHL or TO3 housing.



Key Features

- Continuous Wave
- Single-Mode Spectrum
- Tunable source
- Low Dissipation
- High Beam Quality
- Narrow Linewidth

Key Applications

- Gas Spectroscopy
- Photoacoustic Sensing
- Metrology



HHL package suitable for higher dissipation CW-DFB



TO3 package suitable for lower dissipation CW-DFB

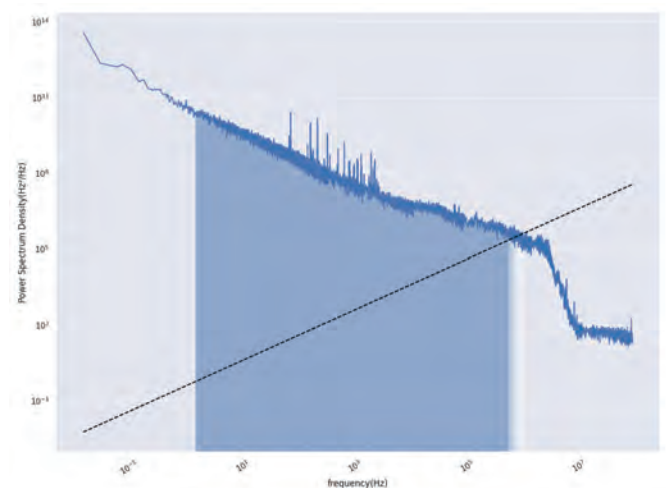

This sample power spectrum density of a 2216.6 cm^{-1} CW-DFB-QCL (measured with a N_2O reference gas cell) allows to extract the FWHM linewidth (from the blue area) of 2.01 MHz over 1 s integration time. The dashed black line is the beta-separation line which corresponds to the upper integration limit for the linewidth determination.

Quantum Cascade Lasers are mid-Infrared light sources which can cover a broad range of wavelengths. In a Distributed Feedback Grating (DFB) device, a grating is etched into the active region of the laser and forces the emission to occur at a very specific wavelength which is determined by the grating periodicity.

For this reason, DFB lasers are also known as Single Mode Lasers. The exact wavelength can be adjusted over a small Tuning Range by changing the operating current and/ or the temperature of operation; the exact wavelengths available from a given laser will be specified in an individual datasheet.

Specifications

PARAMETER NAME	MINIMUM VALUE	TYPICAL VALUE	MAXIMUM VALUE	UNIT	NOTE
Central Wavelength	4.25		12.5	μm	Each laser is specified with a single wavelength or a small range within the available range.
Central Frequency	800		2350	cm-1	
Operating Temperature	-20	20	50	°C	Potential values, only temperatures listed in datasheet are reachable. For lasers in a LLH, HHL or TO3 housing, the chip operation temperature is guaranteed to be reachable with the housing at room temperature (+20°C). For lasers delivered as CoC a method of temperature control is required to operate the laser.
Beam Divergence (Vertical)	40	60	80	°	The beam diffracts strongly at the output facet of a chip-on-submount. Collimated beam output is possible with a proper packaging; see housing brochure for details.
Beam Divergence (Horizontal)	30	40	60	°	
Linewidth	1	1	30	MHz	In theory the instantaneous linewidth of a QCL can be extremely low, of the order of kHz. In practice however, the total noise of a system will almost always be given by the noise of the current driver and/or the temperature noise, and when that noise is much higher than the intrinsic noise you can consider the QCL as a perfect transducer and compute the effective amplitude or spectral noise from the datasheet. For typical commercial drivers the effective noise is on the order of MHz.
Output Power	2	20	200	mW	
Tuning Range	0.5	1	4	cm-1	Lasers tune with the operation temperature and current, tuning range availability depends on the central wavelength. A minimum tuning range can be specified.
Tuning Rate	0.05	0.1	0.2	%	As a percentage of the central wavelength
Storage Temperature	15	20	65	°C	Must be kept above the dew point at all times.

Glider

Alpes Lasers introduces the GLIDER widely tunable mid-IR light source. Based on an external cavity design, the Glider is a monolithic all-in-one light source that requires no assembly or external drivers. The optical output is a single-beam of light whose wavelength can be selected within a range of up to $\sim 850 \text{ cm}^{-1}$.



Key Features

- Large scanning range
- Pulsed operation (CW in some cases)
- Modular
- Graphical interface
- Optional Fibered output
- Full beam steering control capabilities
- Standardized opto-mechanical interfaces
- Integrated acquisition system
- Gaseous purge available

Key Applications

- Material science
- Spectrometry
- System development



Alpes Laser's GLIDER is designed for single-mode operation with wide spectral tunability. The Glider consists of single or multiple quantum cascade laser (QCL) gain chip, a grating-tuned extended optical cavity in Littrow configuration, driver electronics and control software. The system is delivered fully assembled in a closed housing and requires no alignment.

The Glider is available in either a single module configuration or in a multi-module configuration. The multi-module configuration can accommodate up to 4 different modules for larger coverage.

The system comes with a controller providing a Web based graphical user interface allowing access to all the functionalities of the system.

OEM version of the modules can be offered on demand for integration.

Additional Features

- Gaseous purge of the entire systems possible with downstream purge chain connection
- Dual 16 bits channel analog acquisition systems capable of synchronous acquisitions with laser pulses and wavelength
- Real time wavelength 12 bits analog output
- Integrated low level microprocessor providing real time versatile input/output functionality and high customization capabilities.
- Integrated controller running Linux based operating systems with embedded graphical interface and automated scripting measurement capability accessible locally by screen/keyboard/mouse or remotely by RJ45 connection
- Optional fibered output (multimode) with possible switching between free space and fibered output.

Specifications

PARAMETER NAME	MINIMUM VALUE	TYPICAL VALUE	MAXIMUM VALUE	UNIT	NOTE
Spectral Linewidth		1	2	cm ⁻¹	
Gapless tuning range per module	50	200	300	cm ⁻¹	These values may not be achieved by all gain media, the actual values for tuning range, peak power and average power are dependent on the selected gain medium.
Grating period	100		450	gr/mm	The optimal grating for the selected chip(s) will be included in the product. Informative.
300 cm ⁻¹ step time	-	70	-	ms	Time required to move the wavelength by xx cm ⁻¹ and attain stability criteria of +/- 0.5 cm ⁻¹ . Optical output will not stop during this time.
10 cm ⁻¹ step time	-	40	-	ms	
1 cm ⁻¹ step time	-	30	-	ms	
Sweep rate	3400	-	4500	cm ⁻¹ /s	The values for a specific configuration will depend on wavelength and grating selected.
Spectral absolute accuracy	0.2	0.25	0.8	cm ⁻¹	Absolute accuracy of the system between initializations.
Spectral Repeatability	0.015	0.03	0.06	cm ⁻¹	Bidirectional repeatability after initialization.
Maximum peak power	40	100	400	mW	Tuning range, peak power and average power are dependent on the selected gain chip, the values given here are typical for most chips.
Average power	1	5	20	mW	Tuning range, peak power and average power are dependent on the selected gain chip, the values given here are typical for most chips.
Power stability	-	-	5	%	
Pulse width	200	300	CW	ns	Not all chips are capable of CW operation. 300 ns is the typical pulse length used.
Max Pulse repetition frequency	0.066	0.166	1	MHz	Laser chip dependent
Duty cycle	0.1	5	100	%	Not all chips are capable of CW operation. 5% is the typical duty cycle.
Beam quality (M ²)	1	2			
Beam diameter at device output	3	4-5	8	mm	
Beam divergence	-	-	6	mrad	
Pointing stability	-	-	6	mrad	
Laser Operation temperature	0	18	30	°C	Defined by manufacturer, typically 18°C. Other set points on request. Temperatures below atmospheric dew point require a purging of the product.
Cooling	Passive	Water	-		Performances are guaranteed with water cooling. In some particular cases, passive cooling can be enough.
Laser Class	-	-	3B		Exact classification provided individually for each device
Dimensions		528 × 360 × 165		mm	Full system, excluding feet
Weight	-	-	23	Kg	4 chips version
Delivery time	-	-	20	weeks	

Available BG chips

Laser Chip Name	Minimum Tuning Range	Laser Chip Name	Minimum Tuning Range
BG-3.2-3.6	2820-3070 cm ⁻¹	BG-7-8.8	1160-1395 cm ⁻¹
BG-4.4-5.2	1970-2230 cm ⁻¹	BG-7.4-9.7	1060-1320 cm ⁻¹
BG-5.1-6.1	1660-1930 cm ⁻¹	BG-7.3-10.2	1010-1345 cm ⁻¹
BG-5.5-6.2	1635-1780 cm ⁻¹	BG-9.6-12.5	830-1015 cm ⁻¹
BG-6.1-7.4	1375-1615 cm ⁻¹	BG-9.7-13.1	795-1000 cm ⁻¹
BG-6.2-7.4	1380-1595 cm ⁻¹	BG-10.8-13.7	760-900 cm ⁻¹

Partial list of available Broad Gain laser chips that can be integrated into the GLIDER. A more complete list can be found on our website, including narrower gain options and more recently developed options.



GLIDER back side showing controls and connectors

QCL Laser Pointer

The Laser Pointer is a cutting-edge, all-in-one solution designed to meet your alignment operation needs. Equipped with either a Quantum Cascade Laser (QCL) or Interband Cascade Laser (ICL), this integrated system combines a ruggedized opto-mechanic system, driver, and temperature controller for optimal efficiency and precision.



The ultimate alignment tool

The default chip installed in the QCL Laser Pointer is a 8 micron Fabry-Perot (spectally multimode) chip, but other QCL or ICL chips provided by Alpes Lasers can also be installed in this system, ask us for a custom device.

Key Features

- Visible and Mid-IR co-linear beams
- Simple on/off operation
- Push-button or remotely controlled operation
- Active air cooling
- Easy alignment with leveling feet
- Compatible with imperial and metric optical breadboard
- Advanced fixture solutions embedded for OEM integration
- Output Power consistent with Class 1 criteria's for unprotected beam exposure.

Key Applications

- Mid-IR Target Pointer
- Mid-IR/Visible Alignment Beam
- Blinking Beacon



PARAMETER NAME	MINIMUM VALUE	TYPICAL VALUE	MAXIMUM VALUE	UNIT	NOTE
Beam Diameter	3.2	4	4.8	mm	Diameter at internal packaging window exit.
Beam Divergence	–	<6	8	mrad	Divergence, measured at $1/e^2$ from the peak of the distribution.
Beam Central Wavelength	3	8	12	microns	Central Wavelength is dependent on the chip installed; default value is 8.0 ± 0.5 microns but other chips are available on demand.
Pulse Length	–	500	–	ns	
Repetition Rate	–	200	–	kHz	
Output Power	–	5	9.6	mW	Output power is dependent on the chip installed. 9.6 mW max value is necessary for a Class 1 product.

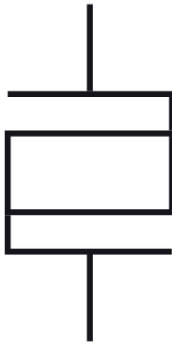

Currently available at 3.95 μm , 4.55 μm , 4.65 μm , 4.9 μm and 9.7 μm
Power up to 1.5W at selected wavelengths

High Power Source

Alpes Lasers introduces its new high power sources. These Quantum Cascade Lasers have a minimum average power of 1W and more than 9W of peak power. Available in a collimated HHL package with a dedicated driver, these lasers can be used for free-space optical communications, energy deposition, illumination and IR countermeasures.

Pulse sequence can be programmed internally or externally controlled through TTL signals. Overcurrent and overheating protection included. Temperature controller not included.

KEY FEATURES

- › High power
- › Collimated source
- › High beam quality
- › Multi-mode spectrum
- › Swiss made

KEY APPLICATIONS

- › Free-space optical communication
- › Energy deposition
- › Illumination
- › IR countermeasures



Class 4 Laser product

SPECIFICATIONS

QUANTITY	ACRONYM	MIN	TYP	MAX	UNIT	NOTE
Spectral Width	SW	50	100	150	cm ⁻¹	–
Min. average power	MAP	1	1.2	1.5	W	1
Peak power	PP	1	3	9	W	2
Output Spectrum	–	–	MM	–	–	3
Duty cycle	DC	–	30	100	%	4
Central Wavelength	CWL	2300	1030 2040 2150 2200 2530	1500	cm ⁻¹	5
Wall-plug efficiency	WPE	10	–	–	%	6
Beam quality	M2	1.5	2	3	–	7
Divergence	MD	–	–	6	mrاد	8
Pointing error	MPE	–	–	6	mrاد	9
Beam diameter	BD	–	4	–	mm	10
Pulse width	PW	20	200	CW	ns	11
Rise/Fall time requirements	RFT	–	10	–	ns	12
Packaging	–	–	HHL	–	–	13
Dimensions	LxWxH	–	33x45x19	–	mm ³	14
TEC current	TECI	1.5	2	3	A	15
TEC Voltage	TECV	9	12	18	V	16
Heatsink cooling capacity	–	25	35	65	W	17
Driver	S-2	–	–	–	–	18
Rise/fall time	RFT	5	6	8	ns	19
Pulse Width	PW	30	200	0	ns	20
Dimensions, laser and driver	LxWxH	–	135x45x22	–	mm ³	21
Lead Time	–	–	6	8	weeks	22

The typical data are taken with 2040 cm⁻¹ laser with typical Peltier current (TECI) cooling with 20 °C water cooled heatsink. These specifications may be changed without further notice.

- This power is attained in pulse mode with about 30% DC. Lower and higher DC operation of the device may exhibit slightly less average power.
- The typical PP is obtained in the max power conditions i.e. 30% DC. The PP reaches its lowest value for CW operation and is maximum at lower DC but does not reach higher than max value even for extremely low DC. It is to be noted that this is also the case for very short pulses, the absolute max ratings for the laser current given in the device datasheet may not be exceeded even for short period of time.
- The output spectrum is Multi Mode (MM). This comes from the existence of several modes in the longitudinal direction, however there is only one mode in the lateral direction.
- The device may operate up to Continuous Wave condition (CW) but its maximum average power output is attained around the typical DC conditions.
- The presently available devices are centered around 3.95 μm, 4.55 μm, 4.65 μm, 4.9 μm and 9.7 μm, devices ranging from min to max indicated value may be ordered with up to 26 weeks lead-time, please enquire.
- This value is obtained at max power conditions.
- Standard value, this specification may be tightened on request.
- Is defined as the FWHM along the fast axis.
- Is defined as the FWHM along the fast axis.
- Measured at the window of the HHL.
- 200 ns is optimum as it provides a good compromise between the time taken to start and stop laser operation where heat is dissipated mostly uselessly and the heating occurring during laser operation. Deviations from this pulse width will thus reduce overall emission performance.
- Using longer rise or fall time may impair the laser performance by overheating the device in conditions where it cannot emit light thus losing efficiency and output power.
- Overall dimensions, excluding 20 mm pins. Other configurations may be adapted, please enquire.
- Overall dimensions, excluding 20 mm pins. Other configurations may be adapted, please enquire.
- The typical values are obtained in nominal conditions, deviations from these conditions towards cooler environment will reduce the cooling requirement and increase them for higher temperature conditions. A heat dissipation capacity of 10 W/K is recommended to ensure the heatsink temperature does not degrade significantly the cooling capacity.
- The typical values are obtained in nominal conditions, deviations from these conditions towards cooler environment will reduce the cooling requirement and increase them for higher temperature conditions. A heat dissipation capacity of 10 W/K is recommended to ensure the heatsink temperature does not degrade significantly the cooling capacity.
- The device is not yet on the shelf but will be introduced Q2 2015
- Values for 20% to 80% of the amplitude. The RFT cannot be set but the shorter being the better, it suits well the laser needs.
- Values at 80% of the amplitude. The driver is capable of generating arbitrary pulse sequences required by your applications. Pulse sequence may be programmed in the driver or controlled externally by means of TTL signals.
- The driver must be screwed directly to the HHL pins to reduce the pulse transmission length. The performances are not guaranteed if the driver is not attached directly to the HHL.
- Leadtime for other Central Wavelength than 2040 cm⁻¹ up to 26 weeks, please enquire.

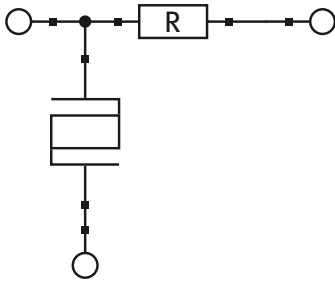

Extended Tuning DFB Source

Alpes Lasers introduces a new class of Extended Tuning DFB, the QC-ET. These QC-ET use a dual current control to extend the mode-hop free tuning to more than 0.4% of the central wavelength ($>6 \text{ cm}^{-1}$ at 1270 cm^{-1}). While the first laser input allows direct intensity modulation in the same manner as standard DFB lasers, the integrated heater current I_T allows to offset the wavelength much faster than the temperature change of the heatsink temperature would do.

Electro-optical Characteristics

QUANTITY	ACRONYM	MIN	TYP.	MAX	UNIT	NOTE
Average power	P	1	–	100	mW	1
Min power tuning range	MPTR	5	6.5	10	cm^{-1}	2
Duty cycle	DC	0	100	100	%	3
Central wavelength	CWL	2325	1270	900	cm^{-1}	4
Laser current	I_L	50	400	600	mA	5
Tuning current	I_T	0	600	1000	mA	6
[Laser] Operation Temperature	T_{opt}	0	10	30	C	7
Operation Temperature	T_{op}	-55	15	30	C	8
Max tuning range @ 1kHz	T-1kHz	3	4	5	cm^{-1}	9
Max tuning range @ 10kHz	T-10kHz	1.5	2	2.5	cm^{-1}	10
Max tuning range @ 100kHz	T-100kHz	0.2	0.4	0.6	cm^{-1}	11
Electrical tuning bandwidth	ETB	2	5	10	kHz	12
Full tuning range	FTR	5	10	15	cm^{-1}	13
Full relative tuning range	FRTR	0.4	0.8	1.2	%	14
	Packaging HHL	–	–	–	–	15
Package size LxWxH		33x45x19			mm^3	15
TEC current	TECI	1.5	2.0	3.0	A	16
TEC voltage	TECV	9.0	12.0	18.0	V	16
Heatsink cooling capacity	–	25	35	65	W	

Key features

- Wavelength and power independent control
- Standard DFB tuning
- Extended tuning at constant heat-sink temperature

Key benefits

- Increased wavelength scanning span fully electrically (Increased electrical wavelength scan)
- Wavelength dither and ramps as in conventional DFB
- DFB wavelength reproducibility
- DFB linewidth and noise



CLASS 3B LASER PRODUCT

Data presented are valid across the spectral range where QC lasers can be manufactured and the typical values are given for a 1275 cm^{-1} laser. These specifications may be changed without further notice.

- Power varies due to the simultaneous change in laser current and wavelength control current necessary to access the full tuning range.
- The MPTR is defined as the attainable wavelength range in which the minimal power of 1 mW is obtained.
- The devices typically operate CW but any type of Laser current modulation is possible within the maximum ratings.
- The extended tuning technology can be applied at any QCL attainable wavelength, please enquire for the lead-time of your wavelength of choice. Presently devices at 1275 cm^{-1} are available at the indicated lead-time.
- The laser current is not changed compared to conventional DFB lasers.
- The electrical tuning current acts as a heat-sink heater control, any current below the max can be used.
- The laser operation temperature may be limited if the heatsinking conditions provided to the package are not sufficient. Higher temperatures are possible but the tuning range may be reduced.
- Operation at higher heat-sink temperatures may cause reduced laser performances.
- The T-1kHz is measured at constant laser current and with a heater modulation of 1 kHz and are given for a 1275 cm^{-1} laser.
- The T-10 kHz is measured at constant laser current and with a heater modulation of 10 kHz and are given for a 1275 cm^{-1} laser.
- The T-100 kHz is measured at constant laser current and with a heater modulation of 100 kHz and are given for a 1275 cm^{-1} laser.
- The ETB is the frequency at which the FM modulation obtained by the electrical tuning is reduced by 3dB.
- From the onset of lasing at Top to the wavelength at max Laser (I_L) and max Tuner (I_T) current. This quantity strongly depends on wavelength as the tuning factor is proportional to the central wavelength. The values here are given for a device at 1275 cm^{-1} .
- The FRTR provides the proportionality between the FTR and the CWL with $\text{FRTR} = \text{CWL} \cdot \text{FTR}$. This value varies for individual devices according to min max specifications.
- Overall dimensions, excluding 20 mm pins. Other configurations may be adapted, please enquire.
- The typical values are obtained in nominal conditions, deviations to these conditions towards cooler environment will reduce the cooling requirement and increase them for higher temperature conditions. A heat dissipation capacity of 10 W/K is recommended to ensure the heatsink temperature does not degrade significantly the cooling capacity.

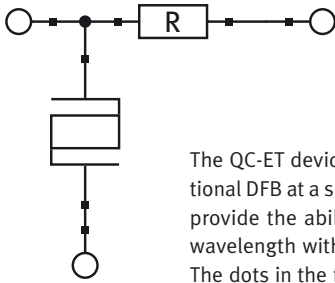

Extended Tuning DFB Source

The QC-ET devices provide a larger tuning than a conventional DFB at a single heat-sink temperature. These devices provide the ability to tune fully electrically the emission wavelength without changing the heat-sink temperature. The dots in the figure show the power at a given emission wavelength and heat-sink temperature for the device used as a conventional DFB i.e. without wavelength current tuning I_T . The shadowed area shows the attainable wavelength and power region for various tuner current (I_T). This area is attainable without changing the heat-sink temperature, widely increasing the speed at which a region of the spectrum may be scanned. Using proper ramps for the laser and tuner current the whole region may be explored at once with speeds in the 100 Hz to kHz range.

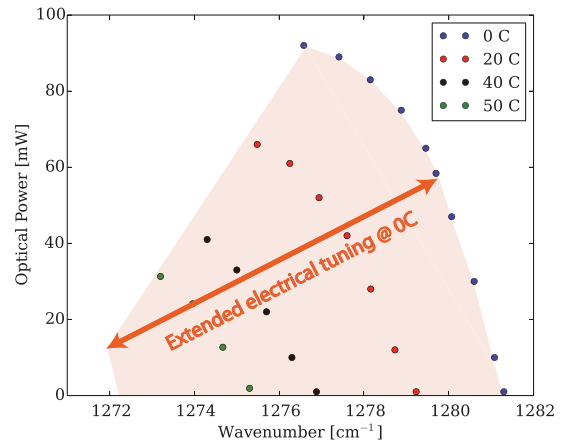

Example of wide scanning of a N_2O gas cell, with fast I_T scans and independent I_T values.

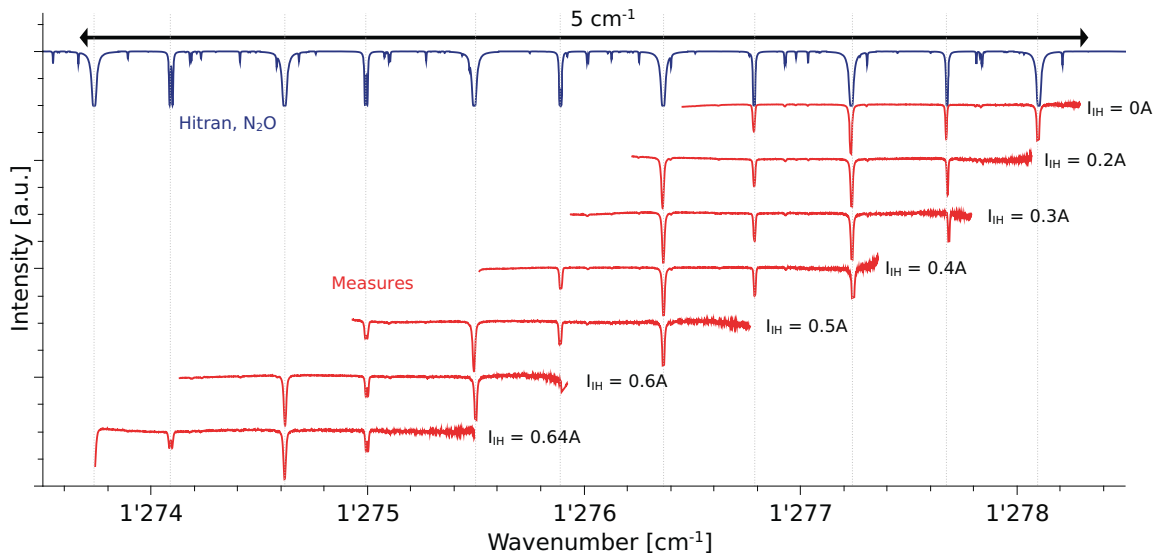

QC-XT Laser Sources

QC-XT extended tuning quantum cascade lasers allow a very large tuning range of up to 2% of the central wavelength (40 cm^{-1} at 5 microns).

The systems is controlled by three independent current inputs. Two inputs control the front and back mirrors of the cavity (I_F and I_B). The laser itself is driven by the laser current I_L and behaves as a normal DFB laser with the available range modified by the values of I_F and I_B . Fig. 1 shows a typical mode of use where using different mirror configurations, a large range spanning from 1268 to 1293 cm^{-1} is attainable with a single laser.

By using different mirror configurations, the laser can be rapidly switched between different configurations, allowing rapid multi-point sampling and/or scanning.

Key Features

- Wavelength and power independent control
- Direct access to any wavelength
- Extended tuning range at constant heat-sink temperature
- Narrow linewidth
- DFB wavelength reproducibility

Key Applications

- Increased wavelength scanning span fully electrically
- Possibility of arbitrary scanning scheme

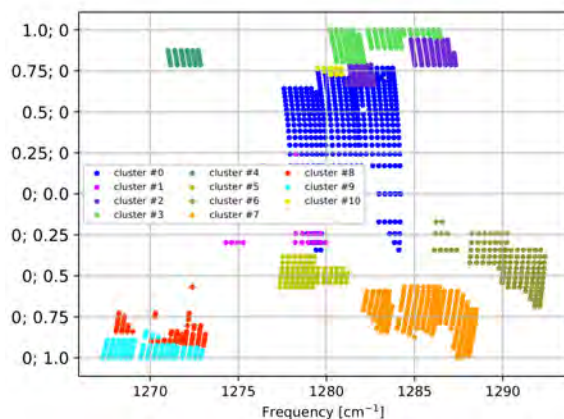
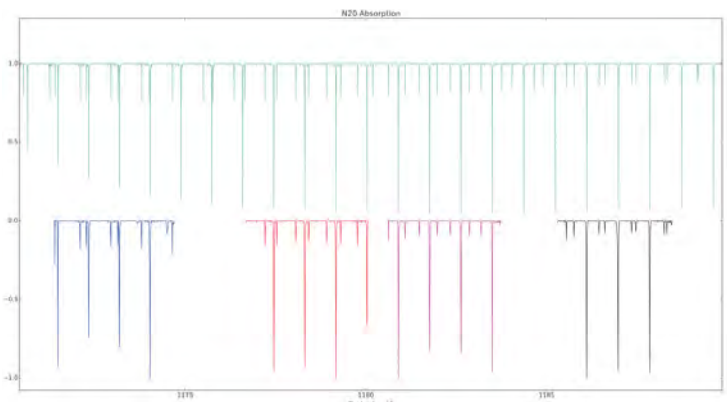

Fig. 1 This pictures shows a typical QC-XT characterization table showing 10 different mirror configuration that can be used to span the 1268 - 1293 cm^{-1} range at fixed temperature.



Fig. 2 QC-XT lasers are typically delivered in HHL housings.

Fig. 3 Example of N_2O spectroscopy performed using four different configurations of a single QC-XT laser.



Specifications

QUANTITY	ACRONYM	MIN	TYP	MAX	UNIT	NOTE
Average Power			5		mW	1
Tuning Range			2.5	4	%	2
Duty Cycle				100	%	3
Wavelength Ranges		1060		1088	cm ⁻¹	4
		1248		1295	cm ⁻¹	
		1536		1604	cm ⁻¹	
		1735		1759	cm ⁻¹	
		2125		2154	cm ⁻¹	
		2154		2209	cm ⁻¹	
Laser Current			400	1500	mA	5
Laser Voltage			11	20	V	
Mirror Current			300	1500	mA	6
Mirror Voltage			4	12	V	
Operation Temperature			15		°C	7
Packaging			HHL			8
Dimensions			33 × 45 × 19		mm ³	9
TEC Current			1	2.5	A	10
TEC Voltage			3	11.6	V	
Heatsink Cooling Capacity		25	35	65	W	11

- 1.** The power emitted varies with laser current.
- 2.** The tuning range corresponds to the extreme excursion from the central wavelength accessible with a device. There can be gaps within the range.
- 3.** The devices typically operate CW but any type of laser current modulation is possible within the maximum ratings.
- 4.** The wavelengths ranges are available from stock. The QC-XT technology can be applied at any QCL attainable wavelength, please enquire for the lead-time of your wavelength of choice.
- 5.** With fixed mirror currents, the laser can be driven solely by the IL in the same manner as a DFB device.
- 6.** The mirror current sources can be fixed and do not require modulation or high compliance for the system to work. The system can function with only one source used at a time.
- 7.** The laser operation temperature may be limited if the heatsinking conditions provided to the package are not sufficient. Higher temperatures are possible but the tuning range may be reduced.
- 8.** Most lasers can be encapsulated in a HHL housing, but some lasers may require a larger XT-LLH housing to reach the required specifications.
- 9.** Overall dimensions, excluding 20 mm pins.
- 10.** The typical values are obtained in nominal conditions, deviations to these conditions towards cooler environment will reduce the cooling requirement and increase them for higher temperature conditions. A heat dissipation capacity of 10 W/K is recommended to ensure the heatsink temperature does not degrade significantly the cooling capacity.
- 11.** At ambient temperature.

Frequency Comb Quantum Cascade Laser

Optical Frequency Combs are devices emitting light on a wide spectrum consisting of equidistant peaks in frequency space. The distance between these peaks being fixed, typically given by the pulse repetition rate of a train of ultrashort pulses, they can be used as rulers in the frequency domain for Frequency Comb Spectroscopy.

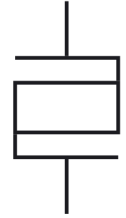

In the mid-infrared range, Quantum Cascade Lasers with specifically engineered optical dispersion have been shown to emit broad and powerful optical frequency combs (OFC). As for ultrashort-pulse lasers, the mode spacing of QCL combs is given by cavity length. However, in the case of QCLs, the periodic modulation in the time-domain is of the FM, not AM, type and the output power is constant.

The wide and flat gain spectrum of Broad Gain Lasers make them suitable for operation as Frequency Combs. As the operating range where comb operation can occur is very sensitive to the fine structure of the heterostructure, each QCL-Comb is tested and qualified.

The QCL comb is a stand alone device as it integrates the pump laser and the microcavity in its waveguide contrarily to other comb technologies. This makes it a very compact comb source. Being based on QCL technology, comb devices can be manufactured over all the MWIR and LWIR.

Dual-comb spectroscopy relies on two OFCs, a sample and a local oscillator (LO) comb, with slightly different comb spacings. The heterodyne beat spectrum of two such combs consists of equally spaced peaks mapping the lasers' optical spectra in the RF domain.

While a similar technique has also been demonstrated using standard Fabry-Perot QCLs, the much narrower intermode beat linewidth of QCLs operating in the comb regime allows to stack a much larger number of beat notes within the RF bandwidth of the optical detector, resulting in higher resolution and/or broader spectral bandwidth.

QCL-based dual-comb spectroscopy offers the possibility to acquire high-resolution spectra over a wide spectral range of several tens of cm^{-1} in a very short acquisition time of the order of μs , i.e. in quasi real time. This technique combines the advantages of DFB-QCLs, i.e. narrow linewidth and mode-hop-free tuning, with the large wavelength coverage of external cavity QCLs.

Key Features

- Compact and robust device.
- Emission in the mid-IR molecular fingerprint region.
- Power per comb tooth in the mW range.
- FM modulated output with constant output power
- Direct generation of MWIR and LWIR radiation with high wall-plug efficiency.
- Can be packaged in HHL or LLH housing

Key Applications

- Dual-comb spectroscopy
- Metrology
- Chemical sensing

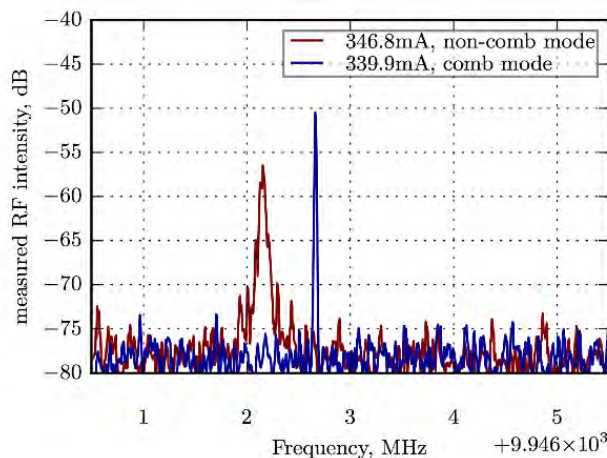

device: sbcw6346,
4.5mm long
-20°C

RF Spectrum of a Frequency Comb laser showing comb operation at an operating current of 339 mA

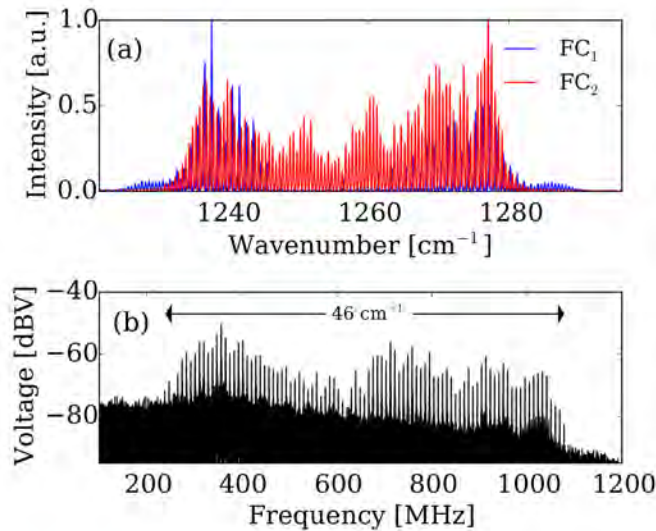

Top: Overlapping optical spectra of two typical Frequency Comb Lasers.

Bottom: Multiheterodyne beating spectrum of two combs, the spectrum spans 46 cm⁻¹ and has a FWHM of 400 kHz

Source: Y. Bidaux et al., Plasmon-enhanced waveguide for dispersion compensation in mid-infrared quantum cascade laser frequency combs, Optics Letter page 1604, vol. 42, n^o8, 2017

Specifications

QUANTITY	ACRONYM	MIN	TYP	MAX	UNIT	NOTE
Central Wavelength	CWL		7.95, 6.02		μm	1
Output Power	P	50	150	200	mW	2
Optical Frequency Span	OFS	50	60	80	cm ⁻¹	3
Number of Comb Teeth	N	100	120	140		4
Intermode Beat Frequency	IF	10,09		14,77	GHz	5
Operating current	I _{op}	600	800	1200	mA	6
Operation Temperature	T _{op}	-20	0	20	°C	7
Operation mode			CW			8
Delivery time			8		weeks	9
Dissipated Power		6	8	14	W	10

- Frequency Comb Technology can be applied at any QCL available wavelength, please enquire for the lead time of your wavelength of choice. Presently lasers around 7.95 microns and around 6.02 microns are available.
- The output power varies with temperature and from one laser to another.
- The optical frequency span will vary with the current and temperature.
- Detailed in device's datasheet
- IBF is 14.77 GHz for a standard 3 mm long laser and 10.09 GHz for a 4.5 mm lasers. By default lasers centered around 6.02 microns are 4.5 mm long and lasers centered around 7.95 microns are 3 mm long.
- DC
- Depends on each specific devices. It may be limited towards higher temperatures.
- Frequency Combs are only stable in CW operation
- At Reception of Order or specified in the quotation.
- By the chip, if packaged, the total dissipation may be larger.

Broadgain Illuminators

Broad Gain Illuminators are Fabry-Pérot lasers designed for maximum width of the gain profile. They can be used as broad spectrum illuminators for spectroscopy or imaging. Combined with an anti-reflection coating, they are suitable for use in an external cavity to obtain a tunable laser with wide tuning range.



Key Features

- Large Spectral Width
- Gapless coverage
- High radiance
- Smooth spectrum possible through dithering

Key Applications

- Mid-IR Illumination
- Globar replacement
- Imaging



Specifications

LASER TYPE	LASER NAME	TYPICAL SPECTRAL RANGE	POWER
Pulsed	BG-5.5-6.2	1670 – 1780 cm ⁻¹	> 50 mW
Pulsed	BG-6.2-7.4	1380 – 1600 cm ⁻¹	> 30 mW
Pulsed	BG-7.4-9.7	1090 – 1280 cm ⁻¹	> 80 mW
Pulsed	BG-9.7-13.1	800 – 980 cm ⁻¹	> 5 mW
Pulsed	P-FP-6.3	1560 – 1620 cm ⁻¹	> 50 mW
CW	BG-CW-5.9-6.2	1640 – 1700 cm ⁻¹	> 100 mW
CW	FP-CW-6.3	1530 – 1585 cm ⁻¹	> 100 mW

Broadgain Illuminators are available in the well-defined bands defined here. Test data is shown for operation as an illuminator devices; refer to the external cavity brochure for EC operation test data for these same chips.

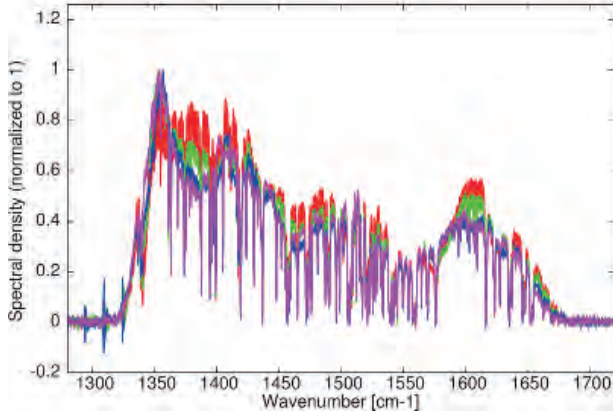

This figure shows a sample spectrum from the BG-6.2-7.4 series which shows the dense coverage that can be reached with these lasers. The different colours correspond to different temperatures of operation. The laser is pulsed in this setup. The narrow dips correspond to narrow water absorption lines in the beam path.

Specifications

PARAMETER NAME	MINIMUM VALUE	TYPICAL VALUE	MAXIMUM VALUE	UNIT	NOTE
Spectral Width	55	200	300	cm ⁻¹	Depends on model chosen
Average Power	5	50	100	mW	Depends on model chosen
Output Spectrum		MM			Multimode spectrum
Duty cycle	0	20	100	%	Only certain models can reach CW operation
Beam Divergence	-	-	6	mrad	Is defined as FWHM along the fast axis
Beam Diameter	-	4	-	mm	Measured at the window of the HHL
Pulse Width	20	300	CW	ns	Only certain models can reach CW operation
Packaging		HHL			Data for HHL shown but chips on submount also available
Dimensions		33*45*19		mm ³	Excluding 20 mm pins
TEC Current	1.5	2	3	A	
TEC Voltage	9	12	18	V	
Heatsink Cooling Capacity	25	35	65	W	A heat dissipation capacity of 10 W/K is recommended to ensure optimal performances.
Lead Time	-	8	-	weeks	

Off-The-Shelf Quantum Cascade IR Lasers



Readily available, off-the shelf
Multiple Wavelengths

- Continuous-wave output
- Single-Mode (DFB)
- Guaranteed output power
- Standard tuning range (wavelength dependant)
- HHL housing
- Collimated beam output

Boston Electronics and Alpes Lasers offer a series of off-the-shelf QCL lasers. The lasers are standard lasers taken from some of Alpes' most popular products. They are pre-encapsulated and respect standard performance levels:

- Continuous-wave output
- Single-Mode (DFB)
- Guaranteed output power
- Standard tuning range (wavelength dependent)
- HHL housing
- Collimated beam output

These lasers are ready for immediate shipment and can be obtained at a low price with a lead time of 2 weeks in most cases for small quantities (up to 3). For larger quantities please contact us directly! qcl@boselec.com

They can also be purchased directly through our Web Store:

<https://shop.boselec.com/collections/quantum-cascade-laser-qcl>

Currently available OTS lasers (5/26):

Part #	Center wave number	Min. power at Center Wavelength	Tuning Range
CW-SM-Q-1030-15-0.9-HHL-L	1030 cm ⁻¹	> 15 mW	> 3 cm ⁻¹
CW-SM-Q-1046.3-5-1-HHL-L	1046.3 cm ⁻¹	> 5 mW	> 2 cm ⁻¹
CW-SM-Q-1103.5-20-0.8-HHL-L	1103.5 cm ⁻¹	> 20 mW	> 3 cm ⁻¹
CW-SM-Q-1900-5-0.5-HHL-L	1900 cm ⁻¹	> 5 mW	> 2 cm ⁻¹
CW-SM-Q-2209-15-1-HHL-L	2209 cm ⁻¹	> 15 mW	> 3 cm ⁻¹
CW-SM-Q-2311-10-1-HHL-L	2311 cm ⁻¹	> 10 mW	> 4 cm ⁻¹

CW Single Mode Laser / CW-SM-Q-1030-15-0.9-HHL-L

CW Single Mode Lasers (or CW-DFB lasers) are able to emit a single wavelength at a time. They can be tuned within a range that can reach up to 10 cm^{-1} ; there exists a variety of modulation schemes which can be used for different purposes. Single Mode Lasers are mostly used for spectroscopy. To be operated in continuous-wave (CW).

Specifications for CW-SM-Q-1030-15-0.9-HHL-L	
Laser type	QCL quantum-cascade laser
Laser Far-field	TM00
Operating mode	CW continuous wave
Emission type	SM singlemode
Target frequency [cm^{-1}]	1030.0 \pm 0.0
Avg optical power [mW]	15.0
Full Tuning [cm^{-1}]	0.9
Temperature Reachable Range [cm^{-1}]	3.0
Is Centered	No
Package Interface	HHL-L
Heatsink temperature max [$^{\circ}\text{C}$]	20
Fabrication time [days]	10

Definitions	
Laser far-field	Spatial mode of the laser in the far field.
Operating mode	Operating mode of the driver electronics.
Emission type	Spectral behavior of the laser.
Target frequency [cm^{-1}]	Target single-mode emission frequency.
Avg optical power [mW]	Average optical power at target emission frequency.
Full Tuning [cm^{-1}]	Emission tuning range accessible by changing the current while keeping the temperature fixed.
Temperature Reachable Range [cm^{-1}]	Emission tuning range from threshold at lowest temperature to maximum current at maximum temperature.
Package interface	Laser packaging: either on ceramic submount, or on copper submount, or in specific housing.
Heatsink temperature [$^{\circ}\text{C}$]	Maximum temperature of the heatsink on which the package will be fixed.

CW Single Mode Laser / CW-SM-Q-1046.3-5-1-HHL-L-V5

CW Single Mode Lasers (or CW-DFB lasers) are able to emit a single wavelength at a time. They can be tuned within a range that can reach up to 10 cm^{-1} ; there exists a variety of modulation schemes which can be used for different purposes. Single Mode Lasers are mostly used for spectroscopy. To be operated in continuous-wave (CW).

Specifications for CW-SM-Q-1046.3-5-1-HHL-L-V5	
Laser type	QCL quantum-cascade laser
Laser Far-field	TM00
Operating mode	CW continuous wave
Emission type	SM singlemode
Target frequency [cm^{-1}]	1046.3 \pm 0.0
Avg optical power [mW]	5.0
Full Tuning [cm^{-1}]	1.0
Temperature Reachable Range [cm^{-1}]	2.0
Is Centered	No
Package Interface	HHL-L
Heatsink temperature max [$^{\circ}\text{C}$]	25
Minimum Voltage [V]	7.0
Maximum Voltage [V]	14.0
Minimum Current [mA]	50.0
Maximum Current [A]	1.2
Fabrication time [days]	70

Definitions	
Laser far-field	Spatial mode of the laser in the far field.
Operating mode	Operating mode of the driver electronics.
Emission type	Spectral behavior of the laser.
Target frequency [cm^{-1}]	Target single-mode emission frequency.
Avg optical power [mW]	Average optical power at target emission frequency.
Full Tuning [cm^{-1}]	Emission tuning range accessible by changing the current while keeping the temperature fixed.
Temperature Reachable Range [cm^{-1}]	Emission tuning range from threshold at lowest temperature to maximum current at maximum temperature.
Package interface	Laser packaging: either on ceramic submount, or on copper submount, or in specific housing.
Heatsink temperature [$^{\circ}\text{C}$]	Maximum temperature of the heatsink on which the package will be fixed.
Minimum Voltage	Low end of the potential range for the operation voltage
Maximum Voltage	High end of the potential range for the operation voltage
Minimum Current	Low end of the potential range for the operation current
Maximum Current	High end of the potential range for the operation current

CW Single Mode Laser / CW-SM-Q-1103.5-20-0.8-HHL-L

CW Single Mode Lasers (or CW-DFB lasers) are able to emit a single wavelength at a time. They can be tuned within a range that can reach up to 10 cm^{-1} ; there exists a variety of modulation schemes which can be used for different purposes. Single Mode Lasers are mostly used for spectroscopy. To be operated in continuous-wave (CW).

Specifications for CW-SM-Q-1103.5-20-0.8-HHL-L	
Laser type	QCL quantum-cascade laser
Laser Far-field	TM00
Operating mode	CW continuous wave
Emission type	SM singlemode
Target frequency [cm^{-1}]	1103.5 \pm 0.0
Avg optical power [mW]	20.0
Full Tuning [cm^{-1}]	0.8
Temperature Reachable Range [cm^{-1}]	3.0
Is Centered	No
Package Interface	HHL-L
Heatsink temperature max [$^{\circ}\text{C}$]	25
Minimum Voltage [V]	7.0
Maximum Voltage [V]	14.0
Minimum Current [mA]	50.0
Maximum Current [A]	1.2
Fabrication time [days]	56

Definitions	
Laser far-field	Spatial mode of the laser in the far field.
Operating mode	Operating mode of the driver electronics.
Emission type	Spectral behavior of the laser.
Target frequency [cm^{-1}]	Target single-mode emission frequency.
Avg optical power [mW]	Average optical power at target emission frequency.
Full Tuning [cm^{-1}]	Emission tuning range accessible by changing the current while keeping the temperature fixed.
Temperature Reachable Range [cm^{-1}]	Emission tuning range from threshold at lowest temperature to maximum current at maximum temperature.
Package interface	Laser packaging: either on ceramic submount, or on copper submount, or in specific housing.
Heatsink temperature [$^{\circ}\text{C}$]	Maximum temperature of the heatsink on which the package will be fixed.
Minimum Voltage	Low end of the potential range for the operation voltage
Maximum Voltage	High end of the potential range for the operation voltage
Minimum Current	Low end of the potential range for the operation current
Maximum Current	High end of the potential range for the operation current

CW Single Mode Laser / CW-SM-Q-1900-5-0.5-HHL-L-V4

CW Single Mode Lasers (or CW-DFB lasers) are able to emit a single wavelength at a time. They can be tuned within a range that can reach up to 10 cm^{-1} ; there exists a variety of modulation schemes which can be used for different purposes. Single Mode Lasers are mostly used for spectroscopy. To be operated in continuous-wave (CW).

Specifications for CW-SM-Q-1900-5-0.5-HHL-L-V4	
Laser type	QCL quantum-cascade laser
Laser Far-field	TM00
Operating mode	CW continuous wave
Emission type	SM singlemode
Target frequency [cm^{-1}]	1900.0 \pm 0.0
Avg optical power [mW]	5.0
Full Tuning [cm^{-1}]	0.5
Temperature Reachable Range [cm^{-1}]	2.0
Is Centered	No
Package Interface	HHL-L
Heatsink temperature max [$^{\circ}\text{C}$]	20
Minimum Voltage [V]	7.0
Maximum Voltage [V]	14.0
Minimum Current [mA]	50.0
Maximum Current [A]	1.2
Fabrication time [days]	56

Definitions	
Laser far-field	Spatial mode of the laser in the far field.
Operating mode	Operating mode of the driver electronics.
Emission type	Spectral behavior of the laser.
Target frequency [cm^{-1}]	Target single-mode emission frequency.
Avg optical power [mW]	Average optical power at target emission frequency.
Full Tuning [cm^{-1}]	Emission tuning range accessible by changing the current while keeping the temperature fixed.
Temperature Reachable Range [cm^{-1}]	Emission tuning range from threshold at lowest temperature to maximum current at maximum temperature.
Package interface	Laser packaging: either on ceramic submount, or on copper submount, or in specific housing.
Heatsink temperature [$^{\circ}\text{C}$]	Maximum temperature of the heatsink on which the package will be fixed.
Minimum Voltage	Low end of the potential range for the operation voltage
Maximum Voltage	High end of the potential range for the operation voltage
Minimum Current	Low end of the potential range for the operation current
Maximum Current	High end of the potential range for the operation current

CW Single Mode Laser / CW-SM-Q-2209-15-1-HHL-L

CW Single Mode Lasers (or CW-DFB lasers) are able to emit a single wavelength at a time. They can be tuned within a range that can reach up to 10 cm⁻¹; there exists a variety of modulation schemes which can be used for different purposes. Single Mode Lasers are mostly used for spectroscopy. To be operated in continuous-wave (CW).

Specifications for CW-SM-Q-2209-15-1-HHL-L	
Laser type	QCL quantum-cascade laser
Laser Far-field	TM00
Operating mode	CW continuous wave
Emission type	SM singlemode
Target frequency [cm ⁻¹]	2209.0 ± 0.0
Avg optical power [mW]	15.0
Full Tuning [cm ⁻¹]	1.0
Temperature Reachable Range [cm ⁻¹]	3.0
Is Centered	No
Package Interface	HHL-L
Heatsink temperature max [°C]	20
Minimum Voltage [V]	7.0
Maximum Voltage [V]	14.0
Minimum Current [mA]	50.0
Maximum Current [A]	1.2
Fabrication time [days]	56

Definitions	
Laser far-field	Spatial mode of the laser in the far field.
Operating mode	Operating mode of the driver electronics.
Emission type	Spectral behavior of the laser.
Target frequency [cm ⁻¹]	Target single-mode emission frequency.
Avg optical power [mW]	Average optical power at target emission frequency.
Full Tuning [cm ⁻¹]	Emission tuning range accessible by changing the current while keeping the temperature fixed.
Temperature Reachable Range [cm ⁻¹]	Emission tuning range from threshold at lowest temperature to maximum current at maximum temperature.
Package interface	Laser packaging: either on ceramic submount, or on copper submount, or in specific housing.
Heatsink temperature [°C]	Maximum temperature of the heatsink on which the package will be fixed.
Minimum Voltage	Low end of the potential range for the operation voltage
Maximum Voltage	High end of the potential range for the operation voltage
Minimum Current	Low end of the potential range for the operation current
Maximum Current	High end of the potential range for the operation current

CW Single Mode Laser / **CW-SM-Q-2311-10-1-HHL-L**

CW Single Mode Lasers (or CW-DFB lasers) are able to emit a single wavelength at a time. They can be tuned within a range that can reach up to 10 cm⁻¹; there exists a variety of modulation schemes which can be used for different purposes. Single Mode Lasers are mostly used for spectroscopy. To be operated in continuous-wave (CW).

Specifications for CW-SM-Q-2311-10-1-HHL-L	
Laser type	QCL quantum-cascade laser
Laser Far-field	TM00
Operating mode	CW continuous wave
Emission type	SM singlemode
Target frequency [cm ⁻¹]	2311.0 ± 0.0
Avg optical power [mW]	10.0
Full Tuning [cm ⁻¹]	1.0
Temperature Reachable Range [cm ⁻¹]	4.0
Is Centered	No
Package Interface	HHL-L
Heatsink temperature max [°C]	20
Minimum Voltage [V]	7.0
Maximum Voltage [V]	14.0
Minimum Current [mA]	50.0
Maximum Current [A]	1.2
Fabrication time [days]	56

Definitions	
Laser far-field	Spatial mode of the laser in the far field.
Operating mode	Operating mode of the driver electronics.
Emission type	Spectral behavior of the laser.
Target frequency [cm ⁻¹]	Target single-mode emission frequency.
Avg optical power [mW]	Average optical power at target emission frequency.
Full Tuning [cm ⁻¹]	Emission tuning range accessible by changing the current while keeping the temperature fixed.
Temperature Reachable Range [cm ⁻¹]	Emission tuning range from threshold at lowest temperature to maximum current at maximum temperature.
Package interface	Laser packaging: either on ceramic submount, or on copper submount, or in specific housing.
Heatsink temperature [°C]	Maximum temperature of the heatsink on which the package will be fixed.
Minimum Voltage	Low end of the potential range for the operation voltage
Maximum Voltage	High end of the potential range for the operation voltage
Minimum Current	Low end of the potential range for the operation current
Maximum Current	High end of the potential range for the operation current

Laser Diode Controllers

6300 SERIES COMBOSOURCE LASER DIODE CONTROLLERS

The **6300 Series ComboSource** Laser Diode Controller offers the best of both worlds: a high accuracy, low noise laser driver and a powerful 60W temperature controller, all in one compact instrument.

The **6300 ComboSource** was born from the proven technology of our LaserSource and TECSource products, and includes several improvements making it our flagship product, providing outstanding performance at a price that does not kill your budget.



6300 Quick Specifications

Model	Milli-Amps	Volts	Laser Connector	QCL
6301	50 / 100	10	DB9	
6305	250 / 500	10	DB9	
6310	500 / 1000	10	DB9	
6340	2000 / 4000	4	DB9	
6310-QCL	500 / 1000	18	DB9	●
6340-QCL	2000 / 4000	15	DB9	●

General Specifications

TEC Power, Connector	5A / 12V / 60W, DB15
Sensors Supported	Thermistor, RTD, LM335, AD590
Remote Interfaces	USB and RS-232
Size (HxWxD) [in (mm)]	3.5 (90) x 8.5 (215) x 12 (305)

Easy to Use, Easy to Configure

Like all our products, you'll find the user interface is easy to setup and use. A dot-pixel character display allows for human-readable status, readings, and errors. No longer do you need to get out the manual to figure out how to set the current limit, or to understand what error 114 is; you can read it directly on the display in plain English. Want to see big numbers from across the room? No problem. Want to see actual versus set point, voltage, and current...all at once? You can do that, too. With a configurable display you can make the instrument work the way you want it to. Its compact form factor means the **ComboSource** takes up less room on your test bench, and the USB and RS-232 computer interfaces make it easy to integrate into your existing test systems.

At a Glance

100mA to 4 Amps
60 Watt TEC
Low noise, dual range
Advanced laser protection
Computer Interface

User Function Keys

The user function keys can be used to quickly select different configuration states or execute a predefined set of commands. Switch between two different experiments or script repetitive actions...anything you can do manually with the instrument can be programmed to the function key.

High Performance Temperature Control

In addition to being an excellent laser driver, the **ComboSource** also functions as a high performance temperature controller. Sixty watts of output power and fully adjustable PID control make it suitable for a wide range of applications.

Dual Range Operation & 4-Wire Sense

The **ComboSource** features dual current operating ranges for improved noise and accuracy for lower current applications without sacrificing headroom for your more power powerful devices. The **ComboSource** also has 4-wire sense for accurate device voltage measurements. This eliminates voltage errors caused by cable and connector resistances.

Full Isolation Means No Ground Loops

Beyond the expected laser protection features, the **ComboSource** adds something unique to the Arroyo family of products: optical isolation of the modulation and photo diode inputs (the computer interfaces are also isolated). This protects against unwanted ground loops and other electrical disturbances that can plague traditional instruments and damage lasers. No other driver on the market has this capability.

Enhanced QCL Capabilities

The **6310-QCL** and **6340-QCL** Controllers are designed to operate at the higher compliance voltages required by QCL lasers.

Independent, Isolated Outputs

With multiple, independent power supplies, the **ComboSource** operates the laser and temperature controller outputs fully independent of each other, with full electrical isolation.

260 SERIES

HIGH-POWER LASERMOUNTS



The 260 series LaserMounts are designed to provide high performance and long term operation. Wire harnesses for various types of lasers are available. Each 260 Series mount can be bolted to an optical table or work surface using holes matching the 1" centers of most optical tables.



CUSTOMIZABLE COPPER COLD PLATE

100% copper cold-plate with mounting holes for common lasers and LEDs, and hard nickel plating for maximum performance and scratch resistance. **Custom mounting configurations available.**



PASSIVE COOLING (MODEL 262)

Take advantage of the 0.25°C-per-Watt cooling efficiency of the Model 262 to maintain low package temperatures.



ACTIVE HEATING AND COOLING (MODEL 264)

The 264 LaserMount includes a built-in Peltier device and temperature sensor for bi-polar temperature control.



STANDARDIZED CABLE CONNECTORS

Connect to Arroyo Instruments laser drivers and temperature controllers with standard cables.



NITROGEN PURGE (OPTIONAL)

The optional 260-C cover with available 1/8" barbed nozzle adapts to a nitrogen supply to eliminate condensation around the laser device.

AT-A-GLANCE

Mounting Plates

- ▶ All Copper Design
- ▶ Breadboard or Multi-Device
- ▶ Customizable Mounting Holes

Cooling Mode

- ▶ Passive Cooling (Model 262)
- ▶ Active Heating & Cooling (Model 264)

Thermal Capacity

- ▶ 0.25°C/W (Model 262)
- ▶ 30 Watts (Model 264)

Also Includes

- ▶ Integrated Fan
- ▶ Optional Laser Harness



OPTIONAL HIGH TEMPERATURE

The 260 Series mounts are available in an optional high temperature configuration, allowing for operation up to 150°C, but retaining the temperature range and thermal capacity of the standard mount. Because thermistors do not perform well at high temperatures, the sensor is replaced with a high accuracy Pt100 RTD sensor.

Contact the factory for a quote.

ACCESSORIES



260-C

COVER FOR 260 SERIES MOUNTS

For applications that need a very stable response or protection of the device, the 260-C is a custom designed cover that fits snugly on top of the fixture, and includes a $\frac{1}{8}$ " barbed nitrogen purge nipple.

RECOMMENDED CONTROLLERS AND CABLES

The right temperature controller for your application depends on the mount and temperature range your application requires:

MODEL 262

5240 or 5305 (depending on laser module requirement) and 1260B cable

MODEL 264

5305 and 1260B cable.

MODEL 264, 150°C

5300-04-15 and 1260B cable, or
5300-08-24 and 1262B cable



Boston Electronics are exclusive North American Technical Sales Agents for Tunable Infrared Quantum Cascade Lasers from Alpes Lasers SA of Switzerland. Alpes Lasers was the first QCL company in the world and offers a variety of QCLs which differ in semiconductor architecture and intended use. This sheet is intended to help you understand the available options and make your choice quicker and easier.

Spectroscopy Grade, Tunable	DFBs	Extremely narrow linewidths tune over a narrow spectral range with high resolution (usually $< 1 \text{ cm}^{-1}$) with milliwatts of power for Beer's Law measurements.
	Extended tuning range DFBs	-XT and -ET series devices with embedded chip features to allow rapid tuning over $> 5 \text{ cm}^{-1}$ or wider - tuning (to $> 2\%$ of center wavelength)
	External Cavities	Extended tuning up to 300 cm^{-1} with linewidths and of 1 cm^{-1} and pulsed operation at mW average power levels
	Frequency Combs	Simultaneous measurement of high-resolution spectra over $> 50 \text{ cm}^{-1}$ enabled by this concept
Compact IR Sources at arbitrary wavelengths	Fabry Perots	Emission bands (gain profiles) from 50 to $> 300 \text{ cm}^{-1}$. Power levels from 10s of mW to $> 1.5\text{W}$ average or $> 20\text{W}$ peak. Applications include chips for external cavities, IR communications and IRCM.

Boston Electronics and Alpes Lasers offer a series of off-the-shelf QCL lasers. The lasers are standard lasers taken from some of Alpes' most popular products. They are pre-encapsulated and respect standard performance levels:

- Continuous-wave output
- Single-Mode (DFB)
- Guaranteed output power
- Standard tuning range (wavelength dependent)
- HHL housing
- Collimated beam output

These lasers are ready for immediate shipment and can be obtained at a low price with a lead time of 2 weeks in most cases for small quantities (up to 3). For larger quantities please contact us directly! qcl@boselec.com

They can also be purchased directly through our Web Store:

<https://shop.boselec.com/collections/quantum-cascade-laser-qcl>

Currently available OTS lasers (5/26):

Part #	Center wave number	Min. power at Center Wavelength	Tuning Range
CW-SM-Q-1030-15-0.9-HHL-L	1030 cm ⁻¹	> 15 mW	> 3 cm ⁻¹
CW-SM-Q-1046.3-5-1-HHL-L	1046.3 cm ⁻¹	> 5 mW	> 2 cm ⁻¹
CW-SM-Q-1103.5-20-0.8-HHL-L	1103.5 cm ⁻¹	> 20 mW	> 3 cm ⁻¹
CW-SM-Q-1900-5-0.5-HHL-L	1900 cm ⁻¹	> 5 mW	> 2 cm ⁻¹
CW-SM-Q-2209-15-1-HHL-L	2209 cm ⁻¹	> 15 mW	> 3 cm ⁻¹
CW-SM-Q-2311-10-1-HHL-L	2311 cm ⁻¹	> 10 mW	> 4 cm ⁻¹

Packaging Options

High Heat Load Housing



Picture of a HHL with collimated beam output. The lens is inside the housing, protected by a tilted window with AR coating. HHL base to be attached on flat heatsink surface using M3 screws

The HHL housing is a sealed collimated housing for CW or pulsed lasers. It is ideal for short-run integration and use in difficult environments. The HHL housing is much smaller than the LLH and is completely sealed. The HHL contains a Peltier junction and a NTC temperature sensor (model 10K4CG), which can be controlled by the TC3 or your own temperature control system. Heat dissipation is

performed by thermal contact with its copper base; the heat dissipation capacity depends on the operation mode and environmental conditions.

There are three versions of the beam output:

- In the standard version, the IR beam is collimated through a chalcogenide glass lens and goes through an AR-coated ZnSe window.
- In the uncollimated version, the lens is absent and the laser source is placed as close as possible from the ZnSe window for a divergent output
- In the pigtailed version a fiber port is added to the HHL and is provided with a ~1-m length of singlemode mid-IR optical fiber.

Key Features

- Max Heat Load 13W
- Collimated output
- Fiber Pigtail connector available

Key Applications

- Integration into industrial systems

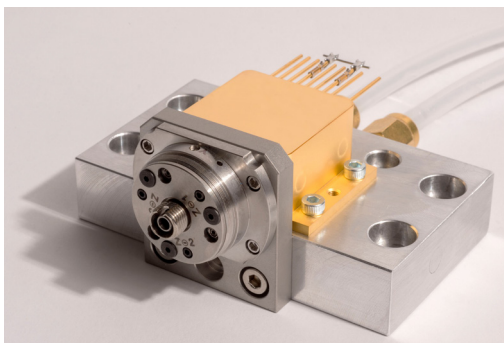

Pigtailed HHL to be delivered with 1-m length of single-mode mid-IR optical fiber. The heatsink shown is also available separately with free-space HHL for easy water cooling.

Specifications

PARAMETER NAME	PARAMETER VALUE				NOTE
	min	typical	max.	unit	
Size	44.5×31.7×19			mm ³	This is the size of the free space HHL. The pigtailed HHL is installed on a fixed heatsink and contains an additional fiber port.
Max. Temperature Differential	30	45		°C	Max. Differential attainable at zero heat load.
Max. Heat Load	6	15		W	Max. heat load to keep chip at room temperature.
Temperature Sensor	NTC, 10 kOhm				
Beam Divergence (Free Space, X axis, < 4500 nm)	2	3,5	6	mrad	Divergence, measured at 1/e ² from the peak of the distribution. Uncollimated option also available.
Beam Divergence (Free Space, Y axis, < 4500 nm)	2	3	5	mrad	Divergence, measured at 1/e ² from the peak of the distribution. Uncollimated option also available.
Beam Divergence (Free Space, X axis, < 11000 nm)	4	5,5	11	mrad	Divergence, measured at 1/e ² from the peak of the distribution. Uncollimated option also available.
Beam Divergence (Free Space, Y axis, < 11000 nm)	3	4,5	8	mrad	Divergence, measured at 1/e ² from the peak of the distribution. Uncollimated option also available.
Pointing error			+/- 3	mrad	Is defined as the FWHM along the fast axis. With respect to the package base reference plane given by pin openings.
ZnSe Window Coating	3-12			µm	The ZnSe window is tilted to avoid back-reflections
Beam Diameter (Free space)			4	mm	Diameter at window exit.
Beam Polarization (TM)	>98			%	Relative to package base plane
Package Sealing	<10 ⁻⁶			cc He/sec	The QCL HHL package is hermetically sealed, the atmosphere inside the package is dry to prevent internal condensation, with <10 ppm H ₂ O.
Fiber Connector (Pigtailed version)	FC/PC				
Fiber Coupling Efficiency (Pigtailed version)	5	15	50	%	The output power in a pigtailed housing will be lower than the output of the chip prior to encapsulation. The coupling is not adjustable, it is fixed and optimized for the expected temperature of operation.
Coupling Repeatability (Pigtailed version)	2,5			%	Repeatability with repeated fiber plugging/unplugging
Numerical Aperture (Pigtailed version)	0,3				
Fiber Length (Pigtailed version)	0,5	1		m	
Single Mode Fiber available			5	µm	Single-Mode Fluoride glass fiber is only available for wavelengths of 5 microns or shorter.
Storage Temperature	-10		63	°C	

These specifications apply for HHL housing with serial number above 2000.

If you have a housing from an older series please enquire for previous specifications.



Picture of a HHL with collimated beam output. The lens is inside the housing, protected by a tilted window with AR coating.

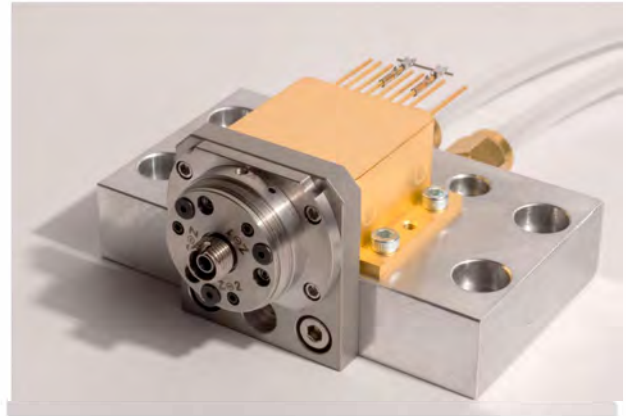

Pigtailed HHL to be delivered with 1-m length of single-mode mid-IR optical fiber. The heatsink shown is also available with free-space beams for easy water cooling.

Specifications

QUANTITY	ACRONYM	MIN	TYP	MAX	UNIT	NOTE
Size			44.5 mm x 31.7 mm x 19 mm		mm ³	1
Max. Temperature Differential			30	60	°C	2
Max. Heat Load			6	16	W	3
Beam Divergence (free space)			5	6	mrad	4
Temperature Sensor			NTC			5
Fiber Connector			FC/PC			6
Fiber Coupling Efficiency		5	15	50	%	7
Coupling Repeatability			2.5		%	8
ZnSe Window Coating			2-12		µm	9
Fiber Numerical Aperture			0.3			10
Fiber Length		0.5	1		m	11
Single-mode fiber available				5	µm	12

- This is the size of the free space HHL. The pigtailed HHL is installed on a fixed base which contains an additional fiber port.
- Max. differential attainable at zero heat load. Will depend on cooler chosen.
- Max heat load to keep chip at room temperature. Will depend on cooler chosen.
- For standard collimated beam. Uncollimated or pigtailed options also available.
- Standard is NTC of Type 10K4CG. pt100 sensor also available.

- For pigtailed housing only
- In the case of pigtailed housing the output of the housing will be lower than the output of the chip prior to encapsulation due to partial coupling to the chip mode. The coupling depends on details of the output facet and is not adjustable. The coupling will be optimized for the expected temperature of operation.
- Repeatability with repeated fiber plugging/unplugging
- The ZnSe window is tilted to avoid back-reflections.

- For 4.7 micron fiber - the value will vary if a different fiber is chosen.
- Standard length - any commercially available length can be chosen, the price of the fiber will be added. Note that attenuation is typically larger for mid-IR than for telecommunication fibers.
- Single-mode Indium Fluoride Glass is available for wavelengths shorter than 5 microns. Other types of fibers are possible, in this case the specifications may change,

RF-HHL Laser Module

Compact Mid-IR Laser with High-Frequency Amplitude Modulation

The RF-HHL Laser Module is a compact mid-infrared laser module offering fast amplitude modulation (AM) via a standard SMA input, providing precise control over the laser's output power and amplitude modulation. The module is packaged in a High Heat Load (HHL) enclosure, making it ideal for demanding environments requiring efficient thermal management, and includes a thermoelectric cooler (TEC), thermistor, and collimating optics.

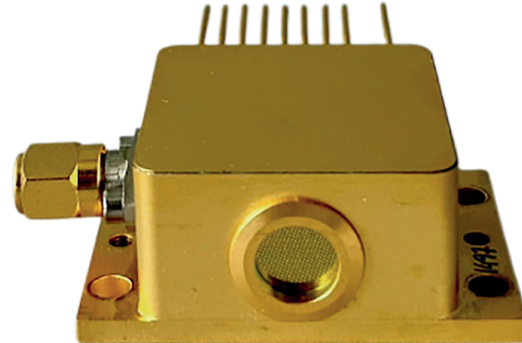

Key Features

- High-frequency amplitude modulation via SMA connector
- Single-mode QCL operation
- 300MHz cutoff at -3dB
- Wavelength range from 3 to 12 μm
- Compact and robust HHL housing

Key Applications

- Gas sensing and environmental monitoring
- Infrared spectroscopy
- Optical signal processing
- OEM integration
- Molecular Dispersion Spectroscopy



This laser module is highly versatile and can be configured with different laser types, including DFB lasers, high-power lasers, and comb lasers, depending on the specific needs of the application.

The RF-HHL offers an exceptional cutoff frequency at 3 dB of greater than 0.3 GHz, making it suitable for high-speed applications that require rapid modulation. The laser's output can be modulated at frequencies far beyond traditional systems, making it ideal for real-time signal processing, gas sensing, and other high-frequency applications.

Specifications

PARAMETER NAME	MINIMUM VALUE	TYPICAL VALUE	MAXIMUM VALUE	UNIT	NOTE
Size	44.5 × 31.7 × 19			mm ³	
Max. Temperature Differential		30	45	°C	Max. Differential attainable at zero heat load.
Max. Heat Load		6	15	W	Max. heat load to keep chip at room temperature.
Temperature Sensor				NTC, 10 kOhm	
Beam Divergence (Free Space, X axis, < 4500 nm)	2	2,8	5	mrاد	Divergence, measured at 1/e ² from the peak of the distribution. Uncollimated option also available.
Beam Divergence (Free Space, Y axis, < 4500 nm)	2	2,5	4	mrاد	Divergence, measured at 1/e ² from the peak of the distribution. Uncollimated option also available.
Beam Divergence (Free Space, X axis, < 11000 nm)	4	5,5	10	mrاد	Divergence, measured at 1/e ² from the peak of the distribution. Uncollimated option also available.
Beam Divergence (Free Space, Y axis, < 11000 nm)	3	4,5	7	mrاد	Divergence, measured at 1/e ² from the peak of the distribution. Uncollimated option also available.
Pointing error			+/- 3	mrاد	Is defined as the FWHM along the fast axis. With respect to the package base reference plane given by pin openings.
ZnSe Window Coating		3-12		μm	The ZnSe window is tilted to avoid back-reflections
Beam Diameter (Free space)			4	mm	Diameter at window exit.
Package Sealing		< 10 ⁻⁶		cc He/sec	The QCL HHL package is hermetically sealed, the atmosphere inside the package is dry to prevent internal condensation, with < 10 ppm H ₂ O.
Output Power		20	100	mW	Higher power can be available for multimode devices
Modulation Input	SMA, analog RF				
Modulation Bandwidth (3dB cut-off)	300 MHz				
Storage Temperature	-10		63	°C	

Pigttailed version is also available.

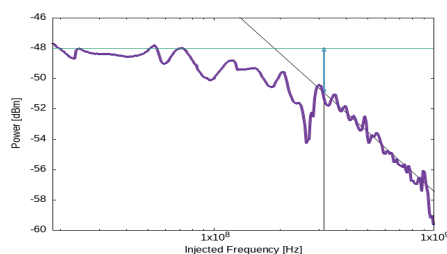

Bode diagram of RF-HHL

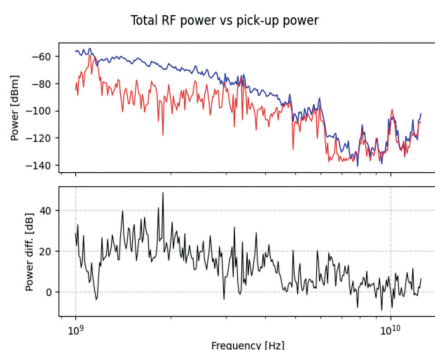

High frequency response of the laser: Measured signal (blue) and background pick-up signal (red), and difference (black).

The frequency response of the RF-HHL module demonstrates outstanding high-frequency performance. Although the nominal 3 dB cutoff is above 300 MHz, measurements show that the amplitude modulation remains detectable well into the multi-GHz range beyond the nominal cutoff point. Although the modulation depth gradually decreases, the system retains more than 20 dB of dynamic range relative to the background pick-up signal.

This extended bandwidth confirms the RF-HHL's suitability for advanced applications requiring fast, high-frequency modulation such as free-space optical communications, high-speed spectroscopy, and fast feedback control.

Datasheet for HHL-27

Recommendations:

Please read the starter kit user manual, if available, and have a look at the FAQ at <http://www.alpeslasers.ch/alfaq.pdf>

WARNING: Operating the laser with longer pulses, higher repetition rate, higher voltage or higher current than specified in this document may cause damage. It will result in loss of warranty, unless agreed upon with Alpes Lasers!

WARNING: Beware on the polarity of the laser. This laser has to be powered with negative pole on the pin 7 and positive pole on the pin 4.

WARNING: Avoid bending module by applying too much torque on mounting screws. Keep temperature change rates below 10 degrees per minute.

MODULE PIN-OUT	Pin n°
TEC (-)	1
Nonexistent	2
Not connected	3
Positive contact of the laser	4
Temperature sensor	5
Temperature sensor	6
Negative contact of the laser	7
Not connected	8
Not connected	9
TEC (+)	10

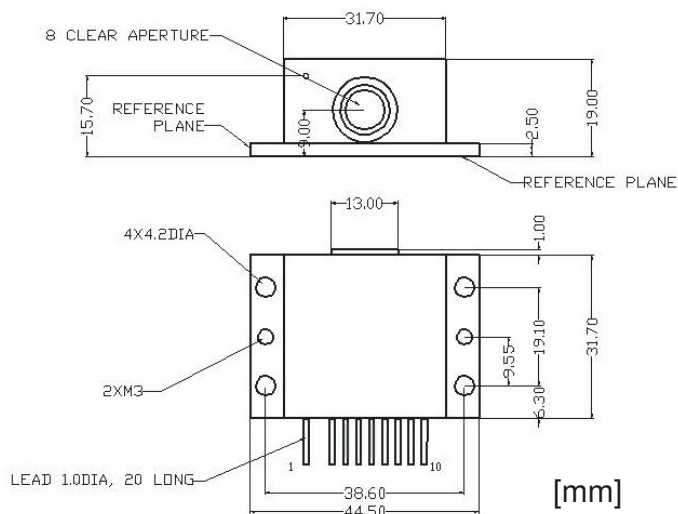

Figure 1: Support mounting for HHL-27 (specifications of the HHL-L module)

Laboratory Laser Housing (LLH)

The LLH is the perfect housing for research applications. With easy laser exchange and compatibility with Alpes Lasers' Starter Kit, it is the most versatile housing available.



- Peltier cooled laser-stage inside, minimal temperature $<-30^{\circ}\text{C}$
- Laser power supply by low impedance line from LDD100
- Anti Reflection Coated (3.5 to 12 μm) ZnSe window.
- Exchangeable laser sub mount (NS or ST).
- Direct voltage measurement on the laser connection, AC coupled.
- Pt100 temperature measurement.
- Needs air or water cooling (water tubing not included)
- Temperature stabilisation, compatible with TC-3
- Can support both CW and pulsed lasers
- Size: 10cm x 5cm x 5cm
- Pin connectors

TO3 Package with Beam Collimation

This option is available for a limited subset of existing pulsed lasers, different from the published pre-tested lasers. Contact us for information.

TO-3 modules are available with AR coated lenses for beam collimation or flat windows.

Technical data

TEC	Value	Units
I_{max}	3.0	[A]
U_{max}	5.9	[V]
Q_{max}	9.8	[W]
$Z_{NTC}(25^{\circ}\text{C})$	10	[k Ω]

WINDOW	Body
ZnSe window	Al body; withstands 1 kg shear stress Leak tested

LENS	Value	Units
Numerical aperture	0.86	-
Clear aperture	4.0	[mm]
Outer diameter	5.50	[mm]
Divergence	<10	[mRad]
Pointing	<10	[mRad]

Physical Characteristics	
Maximum width	38.9 mm
Small axis width	25.9 mm
Distance between screw holes	30.0 mm
Cap width	20.64 mm
Cap height	18.0 mm
Pin length	12.0 mm

Technical drawing

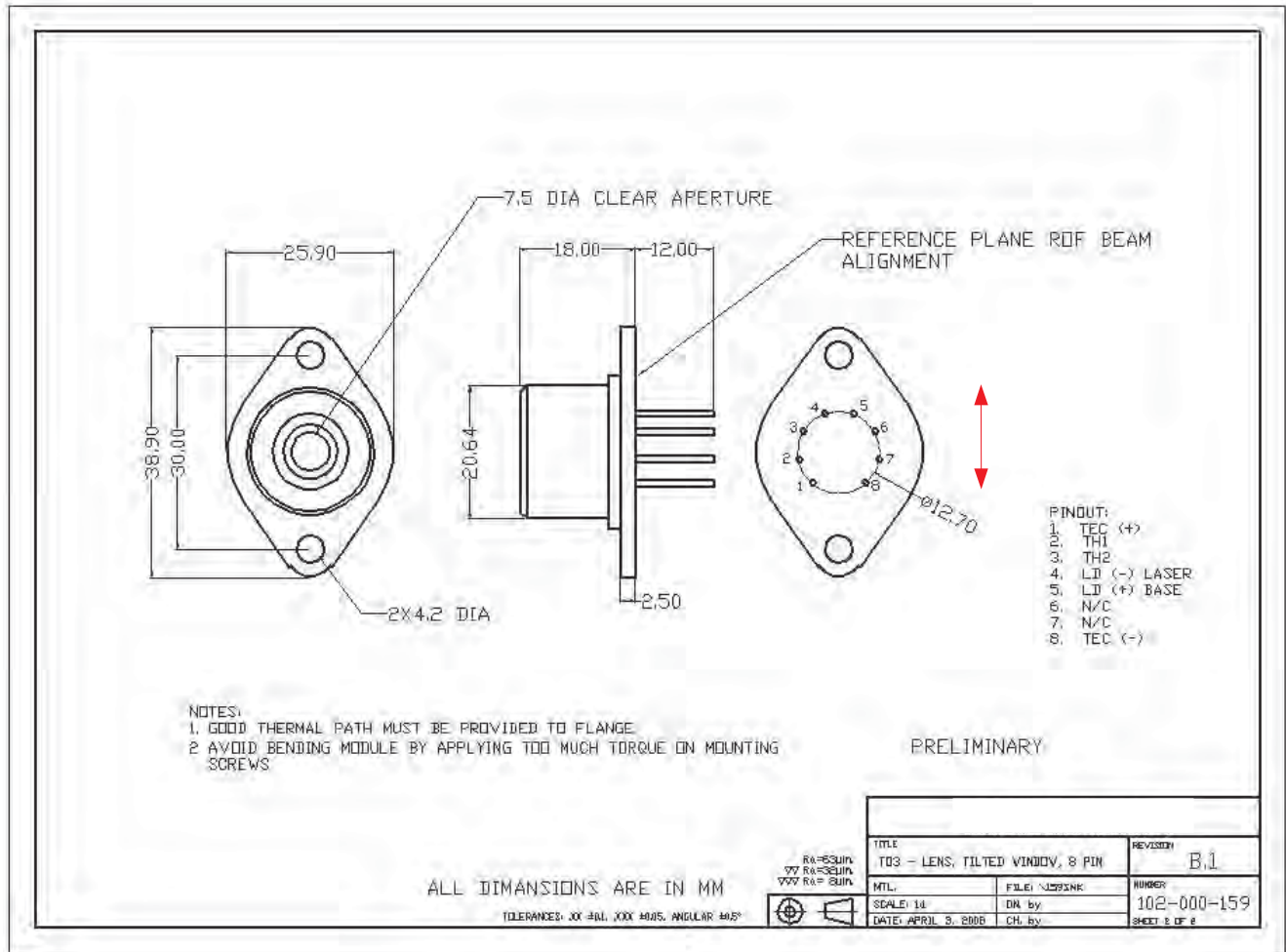

MODULE PIN-OUT	Pin n°
TEC +	1
Thermistor	2
Thermistor	3
Laser bondpad	4
Laser Substrate	5
Not connected	6
Not connected	7
TEC -	8

The polarization (i.e. the electric field) is parallel to the red arrow on the drawing above

TO3 with Divergent Beam

Alpes Lasers offers TO-3 packaging for its product. This option is available for a limited subset of existing pulsed or CW lasers, different from the published pre-tested lasers. Contact us for information.

TO-3 modules are available with AR coated lenses for beam collimation or flat windows.

Technical data

TEC	Value	Units
I_{\max}	3.0	[A]
U_{\max}	5.9	[V]
Q_{\max}	9.8	[W]
$Z_{\text{NTC}} (25^{\circ}\text{C})$	10	[k Ω]

WINDOW	Body
ZnSe window	Al body; withstands 1 kg shear stress Leak tested

Window	Value	Units
Clear Aperture	7.5	[mm]
Facet-window distance	1.1	[mm]

Physical Characteristics	
Maximum width	38.9 mm
Small axis width	25.9 mm
Distance between screw holes	30.0 mm
Cap width	20.64 mm
Cap height	12.0 mm
Pin length	12.0 mm

Technical drawing

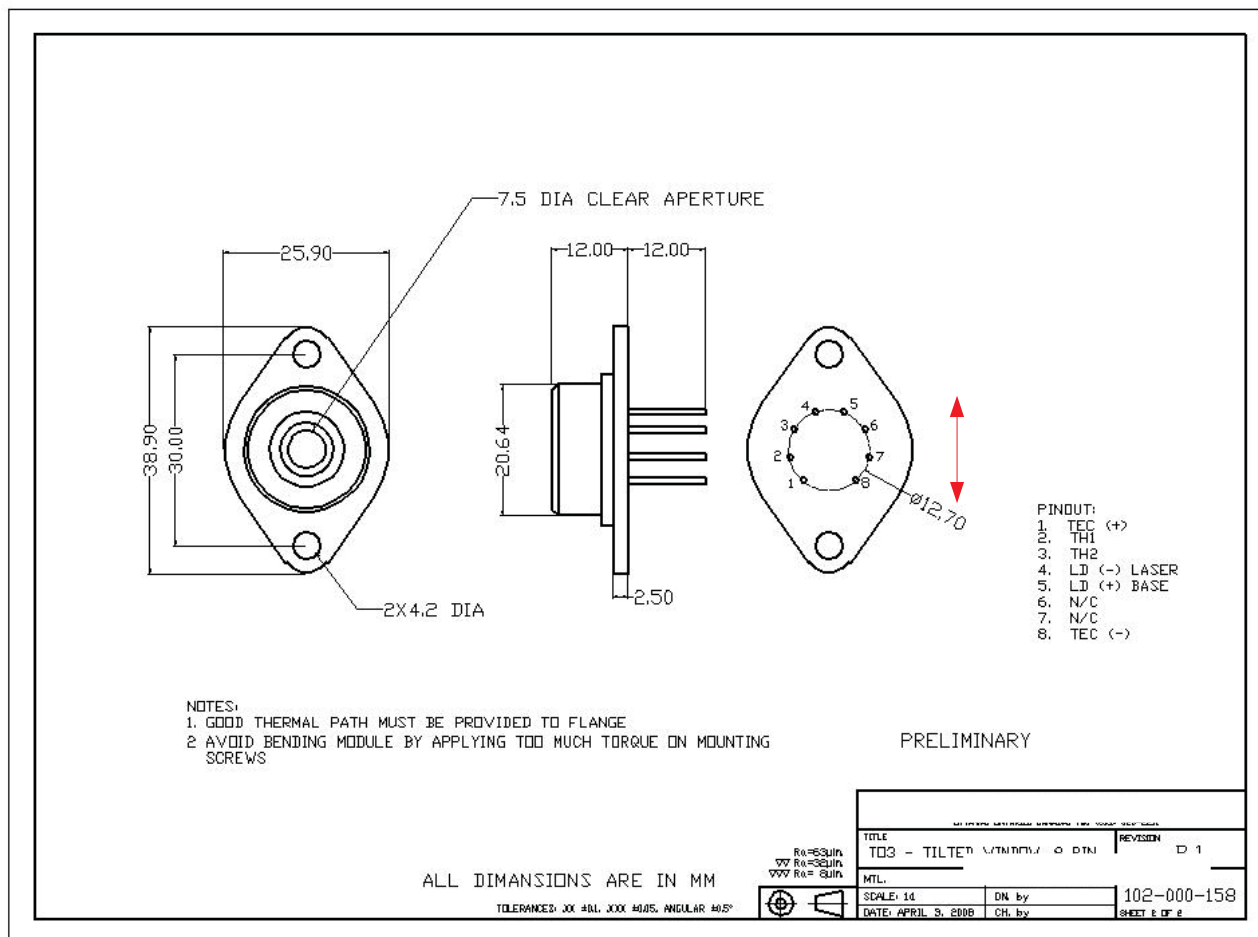

MODULE PIN-OUT	Pin n°
TEC +	1
Thermistor	2
Thermistor	3
Laser bondpad	4
Laser Substrate	5
Not connected	6
Not connected	7
TEC -	8

The polarization (i.e. the electric field) is parallel to the red arrow on the drawing above

Starter Kit

- Entirely manually controllable
- Modular system, devices can be selected or replaced by user
- High temperature operation range -30°C..70°C
- Exchangeable laser sub mount
- Anti Reflection Coated (3.5 to 12 μm) ZnSe window on laser housing
- Monitoring of laser voltage, current, pulse frequency and duty cycle.
- Pulse rate from 0 to 2 MHz
- PT100 temperature sensor, 4 wire measurement
- Internal/External temperature setting
- Monitor-output for real temperature
- Laser overheat-protection by Interlock-system
- Numerous options available (length of the low-impedance line, TC on rack,...)
- Numerous Starter Kits already installed in majors universities and R&D labs all over the world since several years



Quantum Cascade Lasers

- Wide range of wavelengths from 4 to 17 μm
- Operation at room-temperature
- Mono-mode and tunable emission
- Narrow linewidth
- High optical power up to 300 mW
- High reliability and lifetime
- Available on die or mounted on different sub mounts
- Fully independent and individually tested device
- Small size

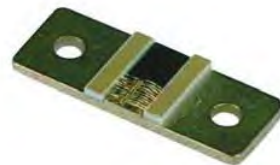

Available wavelength (other wavelengths available on our web site)

Wavelength [μm]	Wavenumber [cm-1]	Application(s)
4.86	2058	CO ₂ , CO
4.87	2055	CO ₂ , CO
5.25	1904	NO, H ₂ O
5.45	1835	NO
6.13	1631	NO ₂
6.28	1592	NO ₂ , NH ₃
7.43	1345	SO ₂ , H ₂ S, CH ₄
7.62	1313	N ₂ O, CH ₄ , H ₂ S
7.85	1274	H ₂ O, CH ₄ , N ₂ O, C ₂ H ₂ , H ₂ S
7.87	1270	H ₂ O, CH ₄ , N ₂ O, C ₂ H ₂ , H ₂ S
9.71	1030	O ₃
10.38	963	NH ₃
11.49	870	CH ₃ Cl

THz Solutions

LN2-P-FP-QCL-136 TeraHertz Quantum Cascade Laser

Far Infrared
Pulsed
Multimode
Cryogenic Temperature
136 cm^{-1}



LN2 dewar

Optical and Electrical Characteristics

Parameter	Min	Typical	Max	Units
Wavenumber range	140	136	133	cm^{-1}
Wavelength range	71	73	75	μm
Frequency range	4.22	4.11	4	THz
Operation temperature	-	77	-	K
Threshold current	-	1.45	-	A
Operation current	1.45	-	2	A
Peak output power	-	2	-	mW

Example: LI Curves and Spectra of LN2-P-FP-QCL-136

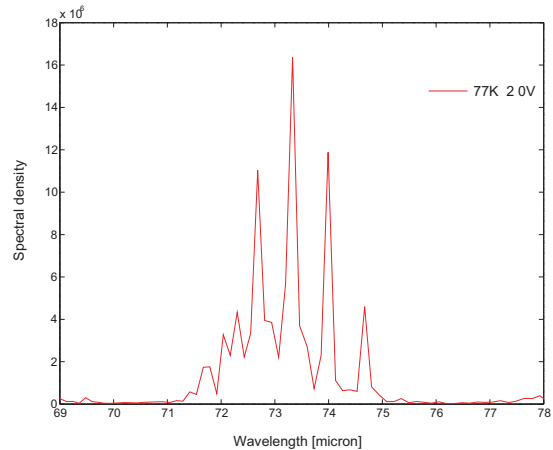
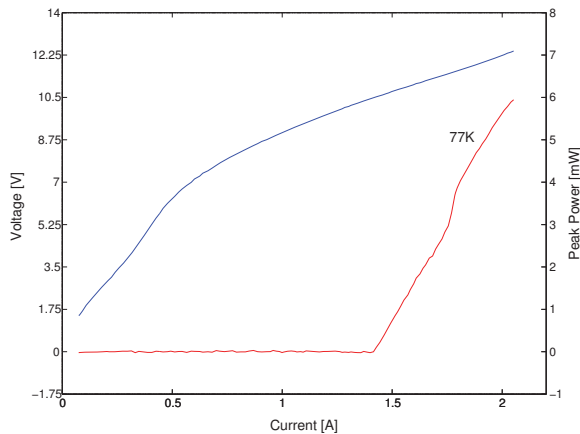

Closed Cycle TeraHertz Source

A portable, plug-in-the-wall, cryogenic-liquid free source of THz light by Alpes Lasers.



- Dimensions : 200 x 250 x 350 mm
- Weight: 17 Kg
- Max. total power consumption: 300W
- Cool-down time to operation ready (65K): 15 minutes
- Minimum operation temperature – cold side: 65K
- Acoustic noise: < 30dB

Dual laser inside. Different spectra available.

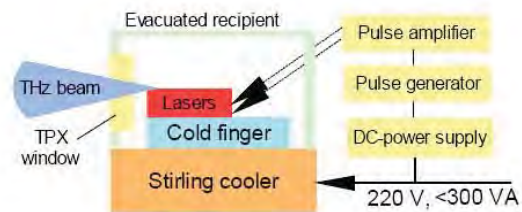
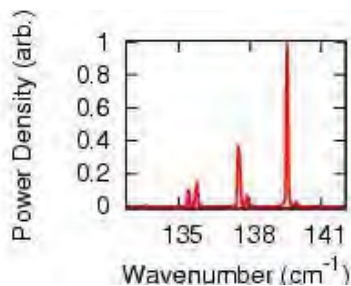

Central Frequency	Central Frequency	Peak Power
1.3 THz	45 cm-1	> 0.1 mW
1.8 THz	60 cm-1	> 0.1 mW
2.3 THz	78 cm-1	> 0.5 mW
3 THz	100 cm-1	> 5 mW
4 THz	133 cm-1	> 5 mW
4.7 THz	160 cm-1	> 1 mW

Accessories

Accessories for use with Alpes Lasers

In an instrument

For a QCL in Alpes TO-3 or HHL package

- Arroyo 6310-QCL Laser Driver and TE Cooler Controller combo instrument
- Thermally conductive heat sink of customer design is valid as long as thermal conductance is sufficient; bolt the package to instrument structure with or without additional heat dispersing elements like radiators or fans.
- Cables from 6310-QCL to HHL: use p/n C0326, 2 meter with HHL 10 pin on one end bifurcated to connectors for TEC and laser driver on 6310-QCL end(s).
- Cables from 6310-QCL to TO-3: use p/n 1221B, 2 meter with pigtailed to solder to TO-3 or socket on one end and 6310-QCL laser driver connector on other end AND use p/n 1261B, 2 meter with pigtailed to solder to TO-3 or socket on one end and 6310-QCL TEC connector on other end
- TO-3 socket is available as p/n C0222



Figure 1, TO-3

In the laboratory

For TO-3 packaged lasers, a PASSIVE heat sink normally works

- Arroyo 6310-QCL Laser Driver and TE Cooler Controller
- 1220B LaserSource Cable
- 1260B TECSOURCE Cable
- 246 TO-3 LaserSource Mount

For HHL packaged lasers, a PASSIVE heat sink

- Arroyo 6310-QCL Laser Driver and TE Cooler Controller
- 1220B LaserSource Cable
- 1260B TECSOURCE Cable
- 244 HHL LaserSource Mount

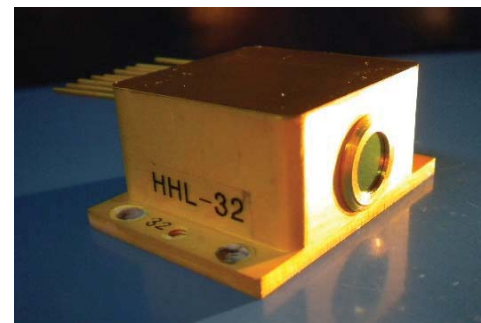

Figure 2, HHL

This should provide HHL operation to -10C, possibly lower.

For LLH housings, use

- Alpes Pulsed Starter Kit with TC-3 cooler controller and S-2 laser pulser for PULSED QCLs [includes cables]
- For CW QCLs, use Alpes TC-3 cooler controller and the Arroyo 4200-01-18-DR driver [cables will be supplied]

To operate the HHL at even lower temperatures, you have options:

1. Arroyo 286-01 – TE cooled sink with additional air-cooling, but rather large. A photo is below shows the cold plate, along with the options for mounting the HHL device: Nearly \$3000 more expensive than the 244 set up

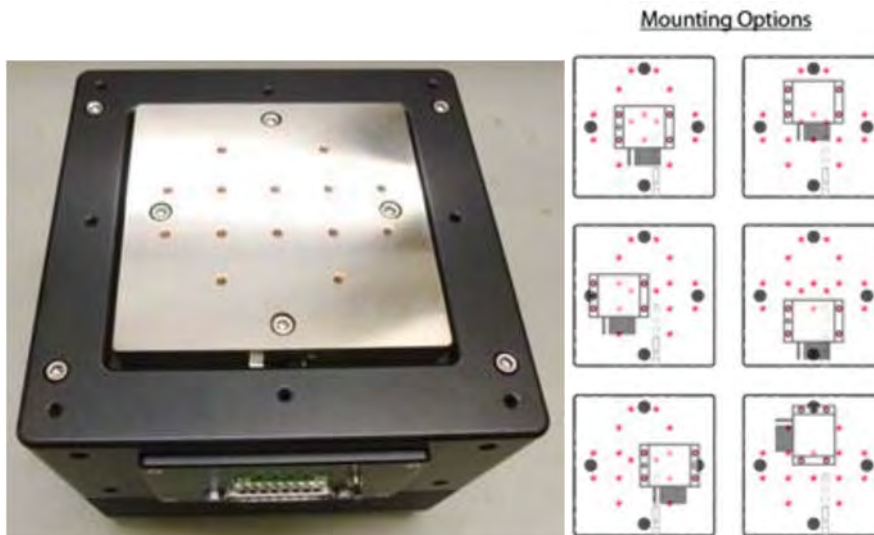

2. Arroyo 274 – TE cooled sink with additional water cooling, much smaller. We have an adapter plate with the mounting holes for the HHL laser so it can be fitted to the 274. About \$1200 more expensive than the 244 set up and needs water.



Both of these options would require different cable sets, specifically the C0326, "LaserSource/TECSource Cable, HHL, 2m. This is a "Y" cable with a HHL connector on one end and the laser/TEC connectors on the other end. It would also require a second TEC controller, the 5305 for this application, that would provide more than enough TEC power to maintain the HHL base temperature.

HHL Heat Sink

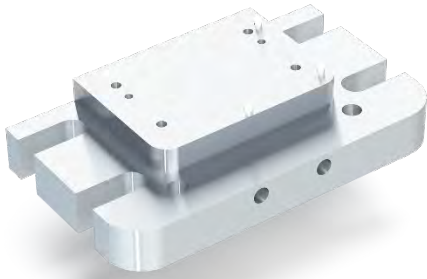

The Alpes HHL heatsink is a water-cooling circuit that can be used to mount the HHL and ensures it operates with ideal thermal performances. While the HHL can be mounted on third-party or proprietary heatsinks (including passive heatsinks) the performances are only guaranteed if the heatsink allows keeping the backplate at +20°C with a 0.1°C/W thermal resistance.

Laser Diode Controllers

6300 SERIES COMBOSOURCE LASER DIODE CONTROLLERS

The **6300 Series ComboSource** Laser Diode Controller offers the best of both worlds: a high accuracy, low noise laser driver and a powerful 60W temperature controller, all in one compact instrument.

The **6300 ComboSource** was born from the proven technology of our LaserSource and TECSource products, and includes several improvements making it our flagship product, providing outstanding performance at a price that does not kill your budget.



6300 Quick Specifications

Model	Milli-Amps	Volts	Laser Connector	QCL
6301	50 / 100	10	DB9	
6305	250 / 500	10	DB9	
6310	500 / 1000	10	DB9	
6340	2000 / 4000	4	DB9	
6310-QCL	500 / 1000	18	DB9	●
6340-QCL	2000 / 4000	15	DB9	●

General Specifications

TEC Power, Connector	5A / 12V / 60W, DB15
Sensors Supported	Thermistor, RTD, LM335, AD590
Remote Interfaces	USB and RS-232
Size (HxWxD) [in (mm)]	3.5 (90) x 8.5 (215) x 12 (305)

Easy to Use, Easy to Configure

Like all our products, you'll find the user interface is easy to setup and use. A dot-pixel character display allows for human-readable status, readings, and errors. No longer do you need to get out the manual to figure out how to set the current limit, or to understand what error 114 is; you can read it directly on the display in plain English. Want to see big numbers from across the room? No problem. Want to see actual versus set point, voltage, and current...all at once? You can do that, too. With a configurable display you can make the instrument work the way you want it to. Its compact form factor means the **ComboSource** takes up less room on your test bench, and the USB and RS-232 computer interfaces make it easy to integrate into your existing test systems.

At a Glance

100mA to 4 Amps
60 Watt TEC
Low noise, dual range
Advanced laser protection
Computer Interface



User Function Keys

The user function keys can be used to quickly select different configuration states or execute a predefined set of commands. Switch between two different experiments or script repetitive actions...anything you can do manually with the instrument can be programmed to the function key.

High Performance Temperature Control

In addition to being an excellent laser driver, the **ComboSource** also functions as a high performance temperature controller. Sixty watts of output power and fully adjustable PID control make it suitable for a wide range of applications.

Dual Range Operation & 4-Wire Sense

The **ComboSource** features dual current operating ranges for improved noise and accuracy for lower current applications without sacrificing headroom for your more power powerful devices. The **ComboSource** also has 4-wire sense for accurate device voltage measurements. This eliminates voltage errors caused by cable and connector resistances.

Full Isolation Means No Ground Loops

Beyond the expected laser protection features, the **ComboSource** adds something unique to the Arroyo family of products: optical isolation of the modulation and photo diode inputs (the computer interfaces are also isolated). This protects against unwanted ground loops and other electrical disturbances that can plague traditional instruments and damage lasers. No other driver on the market has this capability.

Enhanced QCL Capabilities

The **6310-QCL** and **6340-QCL** Controllers are designed to operate at the higher compliance voltages required by QCL lasers.

Independent, Isolated Outputs

With multiple, independent power supplies, the **ComboSource** operates the laser and temperature controller outputs fully independent of each other, with full electrical isolation.



S-2 QCL Pulser

The S-2 QCL Pulser is designed to provide fast, high impedance current pulses to non-linear current driven devices such as quantum cascade lasers. The generated pulses have a rise time between 5 and 15 ns.



The S-2 driver is controlled directly through a computer terminal when the S-2 is connected by a serial or USB cable. Drivers for [Mac OS X](#), [Linux](#) or [Windows](#) computers are available.

If the software requires to upgrade the firmware, you can use the firmware upgrader for [Mac OS X](#), [Windows](#) or for [Linux](#) to upgrade to the latest version.

If your computer does not recognize the USB-RS 232 converter, you can find a driver [here](#); most computers should recognize the converter without a specific installation.

S-2 Pulser Specifications

Max. Repetition Rate	1 MHz
Pulse Width	20ns to CW in 20 ns increment
Max Output Voltage	25V
Voltage Setting Resolution	5 mV
Current Measurement Resolution	2 mA
Max. Current Output	8 A peak, 2.5 A average
Output Voltage Modulation	1 kHz
Bandwidth	1 kHz
Input Voltage	8-20V
Power Supply (included)	18V/40W
External Modulation/Trigger	included
Overcurrent Protection	included

6300 SERIES

COMBOSOURCE DUAL RANGE LASER DRIVER + TEMPERATURE CONTROLLER



The 6300 Series ComboSource is a high-accuracy laser driver combined with a 60W temperature controller. With unique operational modes and safety features not found in other devices, this instrument is ideal for low and medium-power laser and LED applications.



DUAL RANGE LASER DRIVER

Operates at half-scale for improved resolution and lower noise.



OVERLAPPING LASER PROTECTION

Including safety interlock, ESD protection, hardware limits for current & voltage, soft power-on, and intermittent contact safeguards



MULTIPLE OPERATING MODES

Choose from: ● Constant Current ● Constant Power ● Constant Voltage



REMOTE VOLTAGE SENSING

Supports an extra pair of sensing wires to measure the operating voltage of your laser diode or LED.



AUTO-TUNE AND MANUAL PID SELECTION

One button auto-tunes your control loop, or choose from 8 factory gain settings, or select your own.



POWERFUL TEMPERATURE CONTROLLER

Supplies up to 60 Watts of TEC control and up to ± 0.004 °C. Works with a thermistor, LM-335, AD-590, or an RTD.



HIGH CONTRAST VFD MULTI-VIEW DISPLAY

View All 4 At Once: ● Laser Current & Voltage ● Photodiode Current
● Actual & Temp Set Point ● TEC Voltage & Current

AT-A-GLANCE

Current/Voltage Ranges

- ▷ 100 mA / 10 Volt
- ▷ 500 mA / 10 Volt
- ▷ 1 Amp / 10 Volt
- ▷ 4 Amp / 5 Volt

High Accuracy

- ▷ Up to 0.025% of reading
+ 0.025% of scale

Low Noise

- ▷ As low as $<1 \mu\text{A}$

Superb Temperature Stability

- ▷ ± 0.004 °C (over 1 hour)
- ▷ ± 0.01 °C (over 24 hours)

Remote Operation via PC

- ▷ Use your existing control code. Our command set is compatible with other manufacturers.
- ▷ USB / RS-232 Connections



GROUND LOOPS: ELIMINATED. YOUR LASER IS PROTECTED.

A ground loop can destroy your laser in an instant. Every input and control circuit on the ComboSource is electrically isolated. Offset voltages, ground connections, and AC noise will never act on your system.

No other laser driver on the market has this capability.

6300 LASER SPECIFICATIONS

		6301	6305	6310	6340					
Laser	Setpoint	Laser Current								
		Range (mA)	0-50	0-100	250	500	500	1000	2000	4000
		Max Resolution (mA)	0.002	0.005	0.01	0.02	0.02	0.05	0.1	0.2
		Accuracy (\pm [% set+mA])	0.025% + 0.02	0.025% + 0.03	0.025% + 0.08	0.025% + 0.12	0.025% + 0.12	0.025% + 0.3	0.025% + 0.5	0.05% + 0.8
		Stability (ppm, time)	< 10, 1 hour							
		Temperature Coeff (ppm/ $^{\circ}$ C)	50							
		Noise/Ripple (μ A rms)	< 1	< 1.2	< 1.5	< 1.5	< 2.5	< 35	< 40	
		Transients (μ A)								
		Compliance Voltage (V)	10	10	10	10	10	5	5	
		Photodiode Current								
	Range (μ A)	2 – 5,000								
	Resolution (μ A)	0.1								
	Accuracy (\pm [% set+ μ A])	0.05% + 1								
	Stability (ppm, time)	< 200, 24 hours								
	Temperature Coeff (ppm/ $^{\circ}$ C)	< 200								
	PD Bias (V)	0 to -5V, programmable								
	Laser Voltage									
	Range (V)	0 – 10	0 – 10	0 – 10	0 – 10	0 – 10	0 – 5	0 – 5		
	Resolution (V)	0.001								
	Accuracy (\pm [% set+V])	0.05% + 0.005								
Stability (ppm, time)	< 50, 1 hour									
Temperature Coeff (ppm/ $^{\circ}$ C)	< 100									
External Modulation										
Input Range	0 – 10V, 10k Ω									
Modulation Bandwidth (kHz)	325	325	325	200	200	150	150			
Measurement	Laser Current									
	Resolution (mA)	0.002	0.005	0.01	0.02	0.02	0.05	0.1	0.2	
	Accuracy (\pm [% set+mA])	0.025%+ 0.02	0.025%+ 0.03	0.025%+ 0.08	0.025%+ 0.12	0.025%+ 0.12	0.025%+ 0.3	0.025%+ 0.5	0.05%+ 0.8	
	Laser Voltage									
	Resolution (V)	0.001								
	Accuracy (\pm [% read+V])	0.05% + 0.005								
Limits	Photodiode Current									
	Resolution (μ A)	0.1								
	Accuracy (\pm [% read+ μ A])	0.05% + 0.5								
Laser Current										
Resolution (mA)	1									
Accuracy (\pm mA)	2	5	5	10	10	40	40			
Laser Voltage										
Resolution (V)	0.1									
Accuracy (\pm % FS)	2.5%									

www.arroyoinstruments.com



arroyo instruments

800-644-0416

624 Clarion Court, San Luis Obispo, CA 93401

sales@arroyoinstruments.com

6300 TEC SPECIFICATIONS

	6301	6305	6310	6340			
TEC	Setpoint	Temperature					
		Range (°C) ¹	-99 to 250				
		Resolution (°C)	0.01				
		Therm Accuracy (± °C) ²	0.05 ³				
		AD560 Accuracy (± °C) ²	0.05				
		LM335 Accuracy (± °C) ²	0.05				
		RTD Accuracy (± °C) ²	0.05				
		Stability (1hr) (± °C) ⁴	0.004				
	Stability (24hr) (± °C) ⁴	0.01					
	Measurement	Current	Range (A)	5			
			Compliance Voltage (V)	12			
		Max Power (W)	60				
		Resolution (A)	0.01				
		Accuracy (± [% set+mA])	0 + 30				
		Noise/Ripple (mA, rms)	< 5				
		Limits	Current	Resolution (mA)	10		
				Accuracy (± [% read+mA])	0 + 30		
Voltage			Resolution (mV)	10			
			Accuracy (± [% read Volts])	0 + 0.05			
10µA Thermistor	Range (kΩ)		0.2 – 450				
	Resolution (kΩ)		0.01				
	Accuracy (± [% read+kΩ])		0.05 + 50				
100µA Thermistor	Range (kΩ)		0.02 – 45				
	Resolution (kΩ)		0.001				
	Accuracy (± [% read+kΩ])		0.05 + 5				
LM335	Bias (mA)		1				
	Range (mV)		1730 – 4730				
	Resolution (mV)		0.1				
	Accuracy (± [% read+mV])		0.3 + 1				
AD590	Bias (V)		4.5				
	Range (µA)		173 – 473				
	Resolution (µA)	0.01					
	Accuracy (± [% read+ µA])	0.03 + 0.1					
RTD	Range (Ω)	20 – 192					
	Resolution (Ω)	0.01					
	Accuracy (± [% read+Ω])	0.03 + 0.1					
General	Laser Current						
	Resolution (mA)	10					
	Accuracy (mA)	40					
	Display Type	4x20 VFD					
	Laser Connector	DB-9, female					
	TEC Connector	DB-15, female					
	Fan Supply	4 – 12V, 350mA max					
	Computer Interface	USB 2.0 Full Speed (Type B), RS-232 (DB-9, male)					
	Power	100V / 120V / 230V, 50/60 Hz					
	Size (H x W x D) [inches (mm)]	3.47 (89) x 8.5 (215) x 12 (305)					
	Weight [lbs (kg)]	7.8 (3.5)					
Operating Temperature	+10°C to +40°C						
Storage Temperature	-20°C to +60°C						

1. Software limits. Actual range dependent on sensor type and system dynamics.
2. Accuracy figures are the additional error the 5300 adds to the measurement, and does not include the sensor uncertainties.
3. 25°C, 100µA thermistor.
4. Stability measurements done at 25°C using a 10kΩ thermistor on the 100µA setting. The number is ½ the peak-to-peak deviation from the average over the measurement period.

REAR VIEW

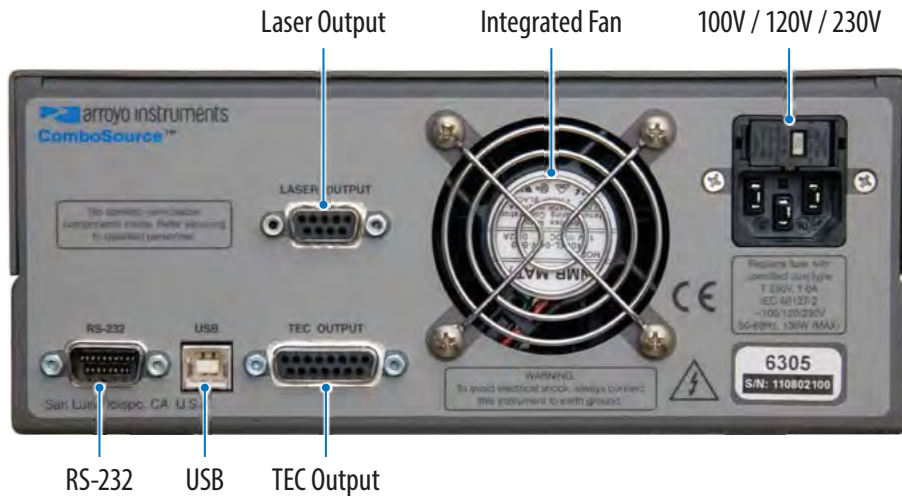

ARROYO CONTROL



Control any Arroyo laser driver or temperature controller directly from your PC. Simply connect to your Arroyo device via USB or RS-232 and gain direct access to settings, device limits, and adjustments from an easy-to-use Windows interface. You can even connect to multiple instruments at the same time.

Download ArroyoControl for free from www.arroyoinstruments.com.

LabView drivers available.



ACCESSORIES



1401-RM-1

6300 SERIES 2U RACK MOUNT KIT, 1 UNIT

This rack mount kit will mount any 6300 ComboSource, 5300 Series TECSource, or 4300 Series LaserSource in 2U of rack space. The unit can be positioned to the left or right side of the rack space, depending on how you mount the hardware.



1401-RM-2

6300 SERIES 2U RACK MOUNT KIT, 2 UNITS

This rack mount kit will mount any 6300 ComboSource, 5300 Series TECSource, or 4300 Series LaserSource side-by-side in 2U of rack space.

www.arroyoinstruments.com



arroyo instruments

800-644-0416

Reference and Tutorials



How to tune a QCL*

Olivier Landry - Alpes Lasers

November 14, 2013

1 Short Pulses for narrow linewidth

The emitted wavelength of a DFB laser is given by the spacing of its Bragg grating, which is affected by temperature. In the case of a pulsed lasers, the sudden onset of electrical dissipation will increase the temperature during the pulse, which will create chirp. We give here some information on this behaviour.

At turn-on, this effect changes the emitted wavelength. The tuning rate is approximately 14 ppm/ns at the outset of the pulse and slows down rapidly after a few ns; the exact rates varying from one laser to another. It follows that, to obtain a narrow linewidth on a slow detector, the pulse length must be kept to a minimum.

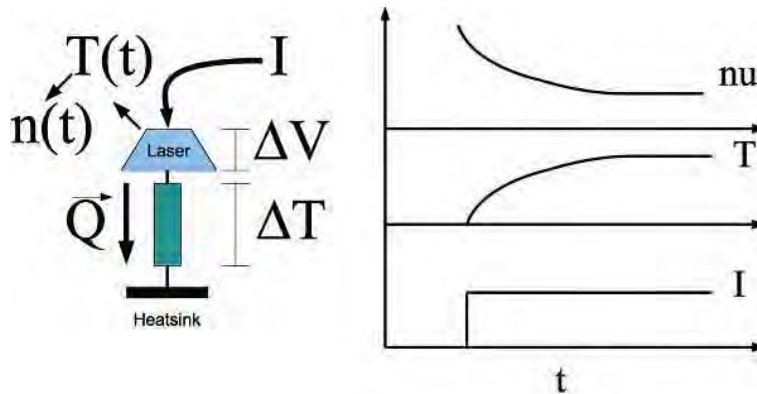

Figure 1: Behaviour at turn-on

The pulsed laser from Alpes Lasers are normally tested on their datasheet using a 50 ns pulse, which results in a noticeable linewidth shown on the datasheet spectra.

A shorter pulse can be used to reduce this linewidth. Using the QCL pulser provided by Alpes Lasers, pulses as short as 22 ns can be created. Dedicated electronics may be able to achieve even shorter pulses. However the non-linear electrical behaviour of QCL make the typical rise and fall-time of the pulse on the order of 8 ns, making very short pulses difficult to achieve.

As a final note, the effective linewidth can also seem to depend on the amplitude of the pulse. This is because there is typically an overshoot at the beginning of a pulse; this is especially pronounced at low

⁰CORID:6881_ArchiveAL-87886

amplitude and very short pulses. It may therefore seem as though a pulse is very short, while it is in fact below threshold, with only a short overshoot being above threshold. An increase in amplitude will then show the true length of the current pulse. You can see on figure 2 a typical shape for a short pulse: the actual spectral behaviour will vary depending on the location of the threshold with respect to the shoulder appearing after 7.9 ns.

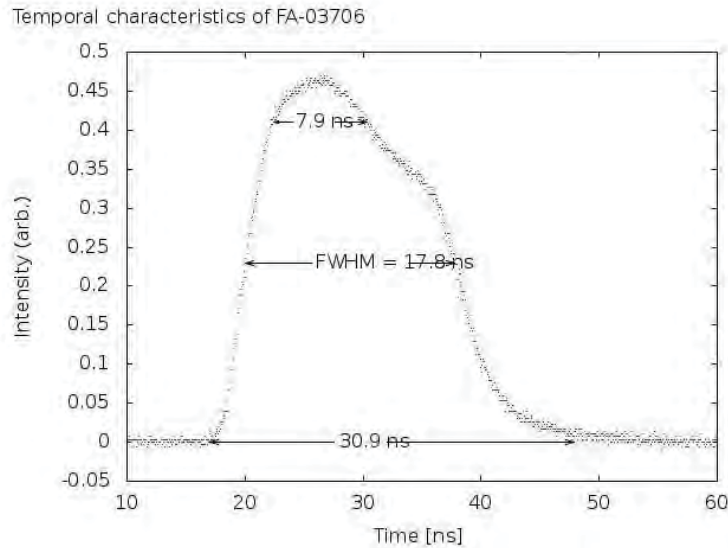

Figure 2: Typical light curve

2 Intra Pulse Modulation

The emitted wavelength of a DFB laser is given by the spacing of its Bragg grating, which is affected by temperature. In the case of a pulsed lasers, the sudden onset of electrical dissipation will increase the temperature during the pulse, which will create chirp. In the Intra-pulse modulation scheme, this chirp is resolved with a fast detector in order to scan through an absorption line.

The final resolution of this method depends on the scanning rate (which depends on the laser) and the detectors integration time. The scanning range can extend up to 2.5 cm⁻¹.

For more information, we refer you to this article published in the Journal of the Optical Society of America B:

http://www.alpeslasers.ch/fichier/papiers/interpulse_modulation_josab_20_8_1761.pdf

Typically, this method is used with pulses length ranging from 200 ns to 1 us. Not every laser chip can withstand such pulses! If you want to use the intra-pulse method, be certain to mention it in your request for quotation. Extra tests can be performed to ensure the suitability of a particular laser for this method.

3 Intermittent CW modulation scheme

One particular interest of quantum cascade lasers is their narrow intrinsic linewidths (down to <1kHz). To achieve a low effective linewidth, however, the driving scheme is important.

Three common driving schemes are inter-pulse modulation, intra-pulse modulation and CW modulation. They are described in more details elsewhere but each comes with their limitation:

short pulse schemes requires either fast current drivers (in the inter-pulse scheme) or fast detectors (in the intra-pulse scheme) to avoid the chirping inherent in pulsed lasers. CW modulation is more demanding on the laser itself and requires large heat dissipation.

We describe here a new scheme, dubbed Intermittent Continuous Wave (ICW) modulation, which allows one to perform spectroscopy with slow detectors and drivers while using lasers in TO-3 cans, which are less expensive than the LLH and HHL housing of true CW lasers.

This scheme was developed in collaboration with the Air Pollution / Environmental Technology group of EMPA.

3.1 Modulation schemes overview

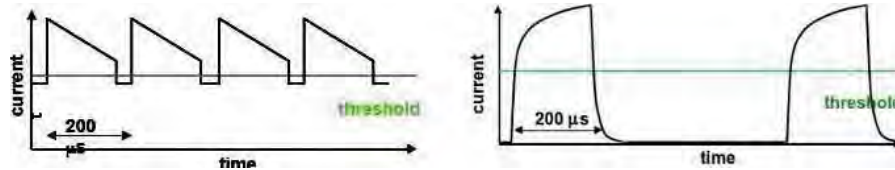

Figure 3: Driving scheme comparison

The image on the top-left shows a typical CW modulation scheme. The driving current is modulated in a saw-tooth pattern to create a frequency modulation over a 200 μs period, which is then followed by a short period below threshold and a repetition. This scheme allows for a slow frequency scanning: if the scanning range is 1 cm⁻¹, then a detector with a 1 μs time resolution will yield a spectral resolution of 0.005 cm⁻¹. The small current excursion ensures limited thermal effects.

Such CW modulation can be used with cooled lasers, for example in a HHL housing. However there are situations where the high footprint and power consumption required for running the laser in a constant-on mode are too high to be sustained.

The ICW scheme, shown on the top-right, diminishes the average dissipation in the laser by dropping the current to zero between pulses, and keeping a longer pause between pulses to allow the cooling down of the laser. Doing that, the overall dissipation is limited and the laser can be used in a TO-3 housing. The thermal excursion is larger which results in a faster transient tuning.

3.2 Requirements

ICW lasers must be lasers that would be capable of running in CW mode given enough cooling power. The ICW mode can be applied to any CW laser in a LLH or HHL housing. In addition, the ICW mode can be applied to a similar chip mounted in a TO-3 housing, but in this case a pure CW mode is not generally possible.

3.3 Ramps

The tuning rate can be controlled by applying a ramp to the current shape. In this case, the first 40 μs of the output is still discarded. Following that, the tuning rate can be increased or decreased by applying a current ramp to increase or decrease the thermal load on the active region of the laser. In this way, the total tuning range within a single pulse can reach up to 2 cm⁻¹.

The following pictures show again typical results. Each lasers will be individually tested.

3.4 Parameter Dependency

The overall tuning is almost entirely independent of submount temperature, but is dependent on duty cycle. Figure 5 shows relative tuning for different temperatures and inter-pulse separation for an identical pulse length.

The tuning endpoints and the tuning rate are both dependent upon the duty cycle. Figure 6 shows absolute tuning with respect to duty cycle. As the pulse-to-pulse separation becomes smaller, the behaviour approaches the monochromatic CW result.

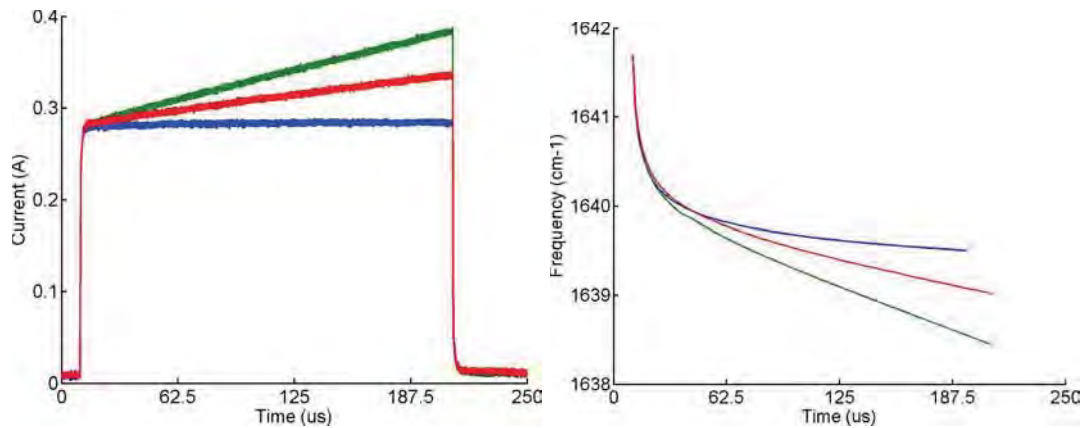

Figure 4: Effects of ramping

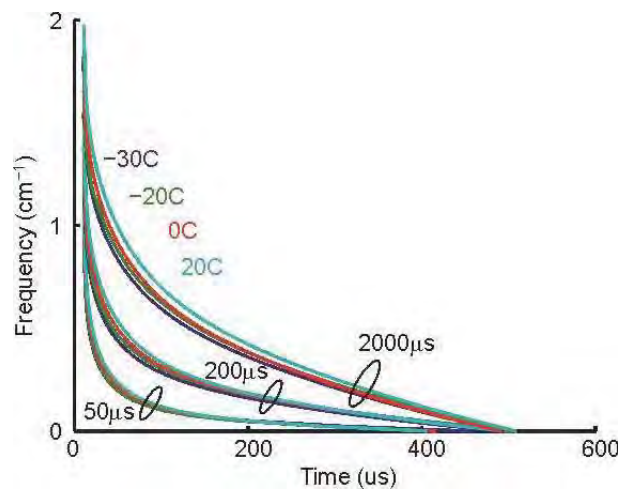

Figure 5: Temperature dependency

3.5 Hardware solutions

Square and sawtooth pulses can be created using programmable CW laser drivers. If you own such a driver you are welcome to use it and we will help you to find the best laser for such an application.

Alpes Lasers is also currently developing a driver fully dedicated to running lasers in the slow-chirp mode. We expect to be able to take orders for such drivers in 2014 - stay posted! Datasheets and Laser evaluation

Every CW laser mounted on NS mounts can be used in slow-chirp mode in a HHL or LLH housing. The datasheets shown on this website only reflects their performance in pure CW mode. If you enquire about these lasers, please precise the mode in which you intend to use them.

Since the long current pulse works by heating the laser, it is safe to assume wavelengths available in CW mode will also be available in ICW mode but with the base temperature being colder by about $10\text{Å}^\circ\text{C}$. The exact temperature shift will be affected by the current used in the laser and the duty cycle. The range available is typically greater than 1.0 cm^{-1} . A specific slow-chirp mode test under your conditions can be performed prior to shipping.

Lasers on NS mounts cannot be mounted in a TO-3 housing. Therefore for a TO-3 laser, please enquire directly by sending us an email at info@alpeslasers.ch

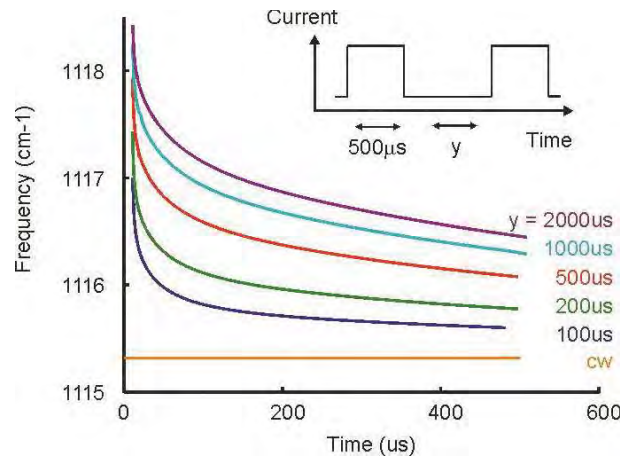

Figure 6: Duty Cycle dependency

4 Bias-T tuning

Since tuning of a QC laser is performed by changing the temperature of the active zone, a small sub-threshold DC bias current can be used to control the emission wavelength of pulsed laser via its heating effect. The LDD driver is equipped to accept a dual input, and this mode of operation is described in more details in Appendix B.3 of the Manual. If you have a gas cell available, you can also follow the sample start-up procedure.

Some of the first reported gas detection experiments were performed using the bias-T tuning method; such as for example the N₂O and CH₄ detection experiment reported in the 1998 Optics Letter available here:

http://www.alpeslasers.ch/fichier/papiers/tildas_ol_23_3_1998.pdf

4.1 Sample Start-up Procedure

To start:

1. Start the laser. A good temp to dial in at first is $\approx 15^{\circ}\text{C}$ so that any moisture inside the package does not condense on the laser chip. Use current settings as indicated in the Alpes test data. You should see energy if you monitor output with a detector.
2. Change the temp to one that should allow the highest frequency (shortest wavelength) of interest.
3. Reset the current to settings appropriate for that temp and wavelength and then reduce it a little bit further, but not below threshold (so you still see energy on the detector)
4. Put a gas cell between laser and detector and verify that you can still see the laser energy on the detector. Write down the value of the amplitude of the detector signal.
5. Turn on the bias T current to a low value (maybe 0.001A) and record the detector signal; repeat at 0.001A increments of bias-T current recording values for each increment until you have reached 0.060 A or some other value that has been discussed/agreed with Alpes.

What the above procedure has done is to generate a spectral scan of the laser over a wavelength region defined by the scan rate of the laser versus current (cm-1/A, a basic property of the laser). A 60 mA range might be equivalent to 1.2 cm-1 of wavelength change in the laser. If your starting point (temp, current) was right, you should see the line of interest in the data when plotted. If not, try again with new temp/pulse current. Continue to optimize the temp and drive parameters:

- Adjust the pulse length lower and higher and repeat the scan; thus learn about the effect of these parameters on power and laser linewidth; explore these to optimize the measurement

- If possible, repeat the measurement with a gas cell with the target gas at low pressure (1 Torr). This will narrow the line greatly and allow you to consider the apparent spectral resolution of the laser itself under the drive conditions and to learn whether the driver has any ringing or double pulsing (which will make the line width seem higher).

In the end you will have calibrated and optimized the laser spectrally as a function of temp and current and the values you have discovered will be much more precise than the values in the data supplied by Alpes (because there can be disagreements in calibration of current or temperature and because Alpes data is at a few discrete settings and your data is with your equipment against your target gas). You can use these optimized values to acquire your real gas data.

5 Direct CW modulation

A CW laser will settle to a fixed wavelength after a transient time of 10 ms; therefore you can modulate the laser with a signal slower than 100 Hz and expect the output wavelength to faithfully follow the input current with the relation measured in its datasheet.

CW lasers can also be modulated more quickly. The emitted power will follow the current amplitude faithfully at high speeds; for reference you can see this paper describing a free-space link functioning at 330 MHz:

http://www.alpeslasers.ch/fichier/papiers/blaser_el_37_778_2001.pdf

However the wavelength modulation being a thermal effect, it will be suppressed at speeds exceeding 1 MHz, and will decrease monotonously between 100 Hz and 1 MHz. Graph 7 shows data for an amplitude a specific laser; the exact values will vary from one laser to the next.

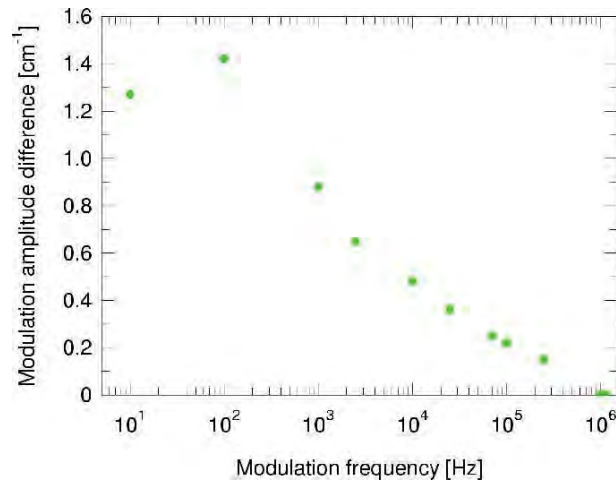
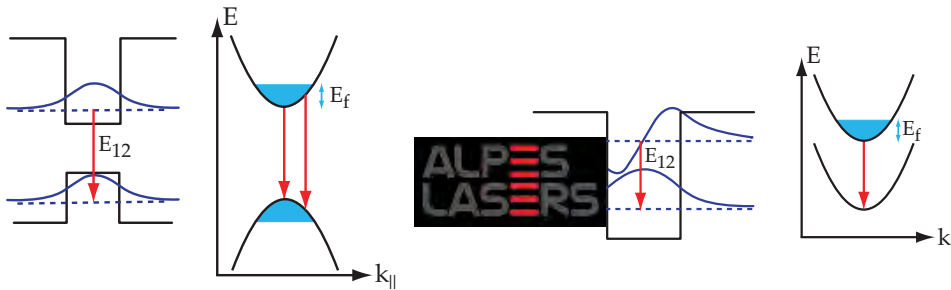

Figure 7: Modulation speed effect



Quantum cascade lasers

Interband vs intersubband



- **Interband transition**

- bipolar
- photon energy limited by bandgap E_g of material
- Telecom, CD, DVD,...

- **Intersubband transition**

- unipolar, narrow gain
- photon energy depends on layer thickness and can be tailored

Quantum cascade lasers

- **Cascade**

- each e- emits N photons

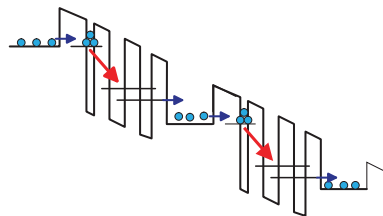

- **Active region / injector**

- active region \rightarrow population inversion which must be engineered
- injector \rightarrow avoid fields domains and cools down the electrons

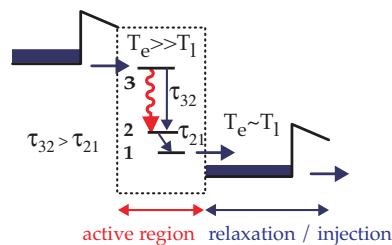

- **MBE**

- growth of thin layers
- sharp interfaces

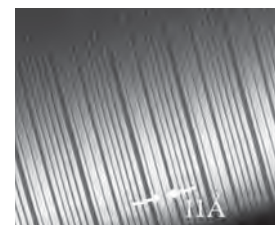

State of the art: QCL performances

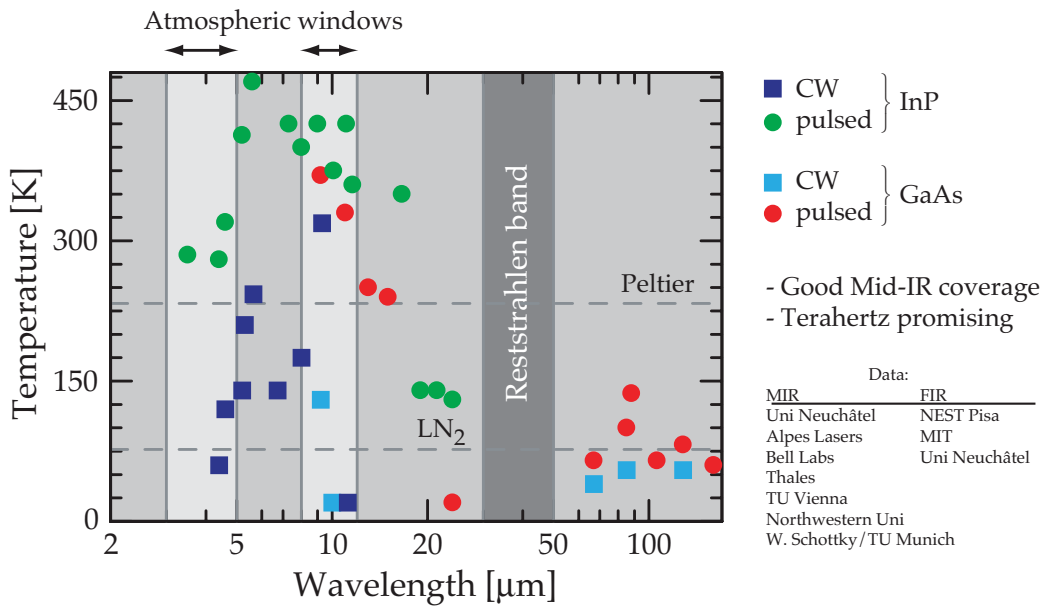

Designs

Double-phonon resonance:

(patent n° wo 02/23686A1)

- 4QW active region with 3 coupled lower state
- lower states separated by one phonon energy each
- keeps good injection efficiency of the 3QW design

Hofstetter *et al.* APL **78**, 396 (2001).

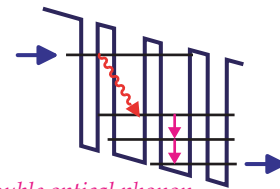

Double optical phonon resonance

Bound-to-continuum:

(patent n° wo 02/019485A1)

- transition from a bound state to a miniband
- combines injection and extraction efficiency
- broad gain curve -> good long-wavelength and high temperature operation

J. Faist *et al.* APL **78**, 147 (2001).

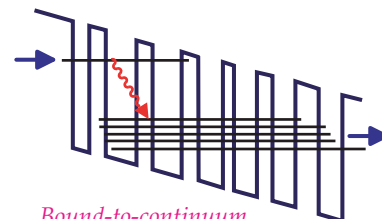

Bound-to-continuum

Two-phonon structure at 8 μm

Based on two-phonon resonances design

InGaAs/InAlAs-based heterostructure with $\Delta E_c = 0.52\text{eV}$

Grown by MBE on InP substrate

35 periods

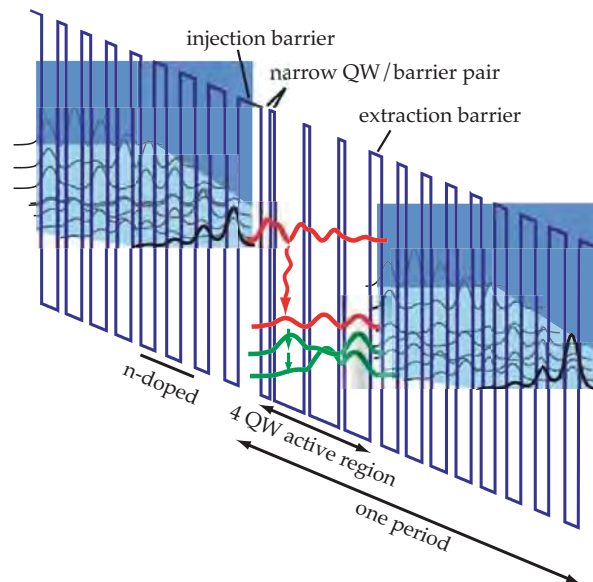

41, 16, 8, 53, 10, 52, 11, 45, 21, 29, 15, 28, 16, 28, 17, 27, 18, 25, 21, 25, 26, 24, 29, 24

High average power FP QCL

RT-HP-FP-150-1266

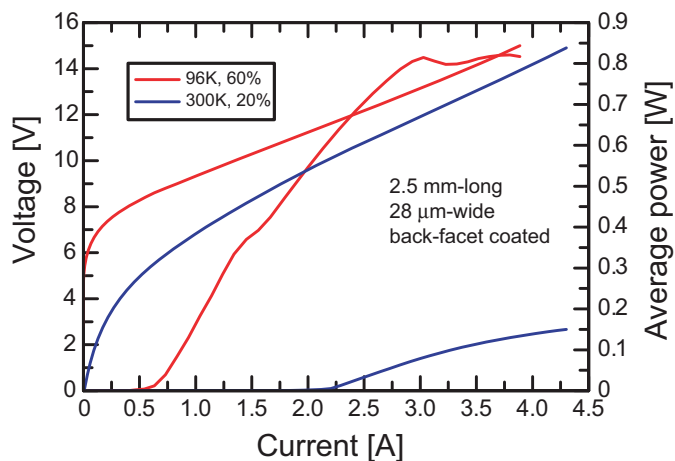

Characteristics

$\lambda = 7.9 \mu\text{m}$

@300K: Average power:

$P = 150 \text{ mW}$

threshold current:

$I_{th} = 2.1 \text{ A}$ ($j_{th} = 3.0 \text{ kA/cm}^2$)

@96K : $P = 0.82 \text{ W}$ (60% dc)

$I_{th} = 0.51 \text{ A}$ ($j_{th} = 0.75 \text{ kA/cm}^2$)

CW: $P = 300 \text{ mW}$

($j_{th} = 0.78 \text{ kA/cm}^2$)



Single-mode operation: distributed-feedback QCLs

How does a DFB work?

Fabry-Pérot laser:

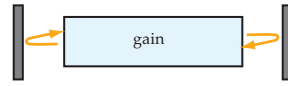

Amplified light bounces in the cavity

DFB:

periodic grating => waves coupling
=> high wavelength selectivity



complex-coupled DFB:

- lasing mode closest to the stopband
- stopband \approx coupling strength

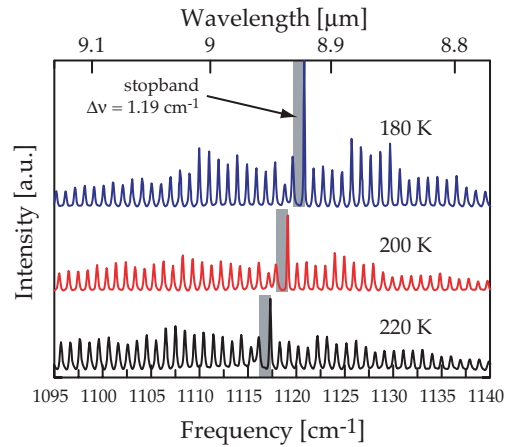

Distributed-feedback technologies

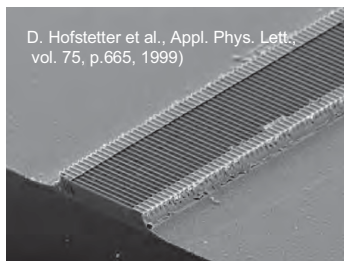

Grating on the surface (open-top)

- one MBE run (no MOCVD)
- high peak power (large stripes) but low average power
- optical losses due to metalization

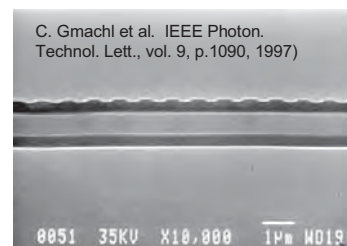

Grating close to active region

- lower thermal resistance (high duty / high temperature)
- high average power
- higher overlap, smaller losses
- jct dn mounting possible
- needs MOCVD regrowth

High average power DFB QCL

RT-HP-DFB-20-1200

Distributed feedback QC laser at 8.35μm with InP top cladding

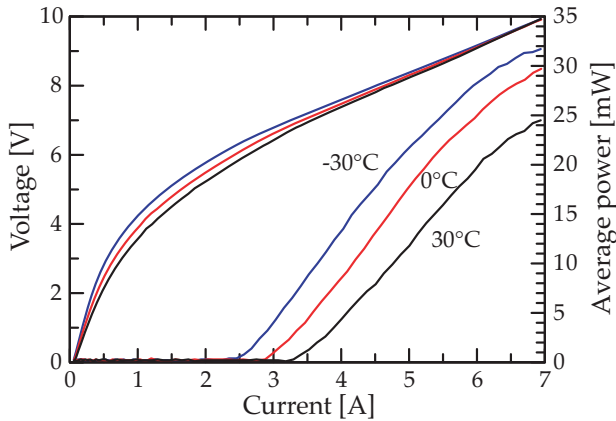

Characteristics

3mm-long, 28μm-wide laser
 $\lambda \approx 8.35 \mu\text{m}$

@-30°C: Average power (2% dc):
 $P = 32 \text{ mW}$ (1.6 W peak power)
 threshold current:
 $I_{\text{th}} = 2.44 \text{ A}$ ($j_{\text{th}} = 2.9 \text{ kA/cm}^2$)

@30°C : $P = 25 \text{ mW}$ (1.25W peak power)
 $I_{\text{th}} = 3.2 \text{ A}$ ($j_{\text{th}} = 3.8 \text{ kA/cm}^2$)

High average power DFB QCL

RT-HP-DFB-20-1200

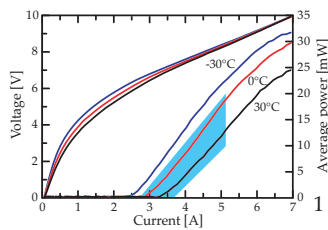

Characteristics

Entire tuning range:
 $\Delta\nu = 5.7 \text{ cm}^{-1}$ at 1197 cm^{-1} (0.47%)
 (1195.2 cm^{-1} (8.367 μm) at 30°C to 1200.9 cm^{-1} (8.327 μm) at -30°C)

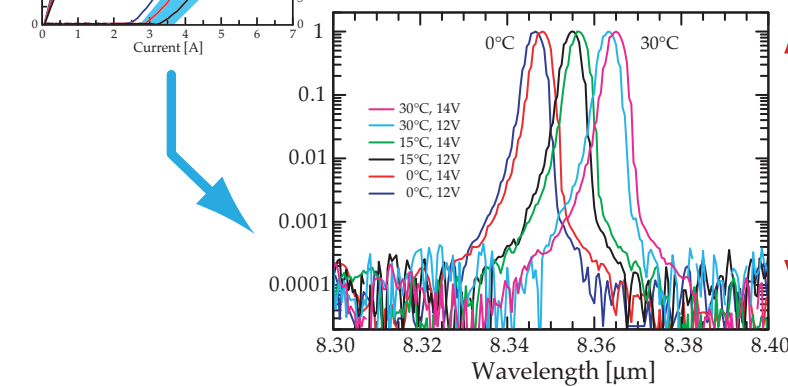

40 dB (limited by the grating spectrometer)

Long-wavelength ($\lambda \approx 16.4 \mu\text{m}$) B2C DFB QCL

RT-P-DFB-1-608

Laser based on a bound to continuum design, $\lambda \approx 16.4 \mu\text{m}$

Rochat et al., APL **79**, 4271 (2001)

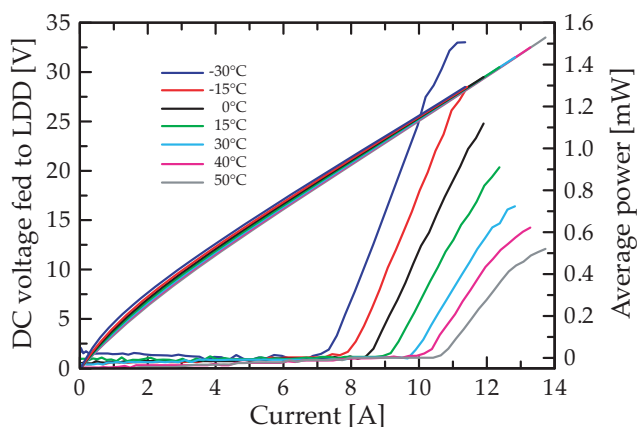

Characteristics

3 mm-long, $44 \mu\text{m}$ -wide laser
 $\lambda \approx 16.4 \mu\text{m}$

@-30°C: Average power (1.5% dc):
 $P = 1.5 \text{ mW}$ (100 mW peak power)
 Threshold current:
 $I_{\text{th}} = 7.1 \text{ A}$ ($j_{\text{th}} = 5.4 \text{ kA/cm}^2$)

@50°C: $P = 0.5 \text{ mW}$ (33 mW peak power)
 $I_{\text{th}} = 10.4 \text{ A}$ ($j_{\text{th}} = 7.9 \text{ kA/cm}^2$)

Long-wavelength ($\lambda \approx 16.4 \mu\text{m}$) B2C DFB QCL

RT-P-DFB-1-608

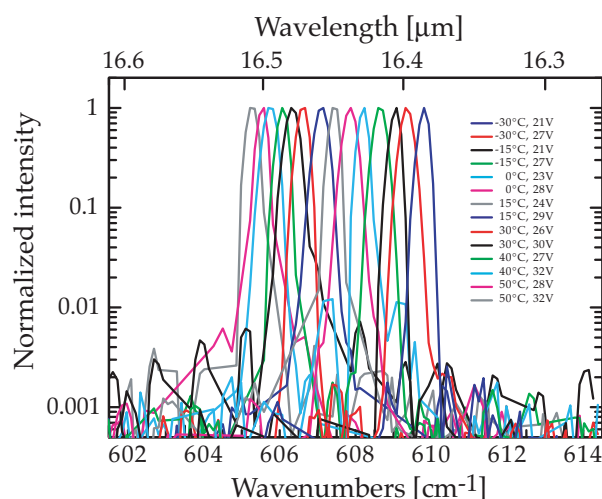

Characteristics

3mm-long, $44 \mu\text{m}$ -wide laser
 $\lambda \approx 16.4 \mu\text{m}$

Single-mode emission:
 Side Mode Suppression Ratio > 25 dB
 (limited by the resolution of the FTIR)

Tuning range:
 $\Delta\nu = 4.5 \text{ cm}^{-1}$ at 608 cm^{-1} (0.7%)

(605.76 cm^{-1} ($16.51 \mu\text{m}$) at 50°C to
 610.30 cm^{-1} ($16.38 \mu\text{m}$) at -30°C)

How does a DFB tune?

How does a DFB tune?

Tuning always due to thermal drift

(carrier effects can be neglected!)

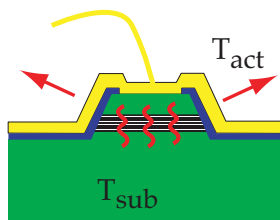

wavelength selection : $\lambda = 2 \cdot n_{eff} \cdot \Lambda_{grating}$

$$n_{eff} = n_{eff}(T)$$

$$\frac{d\lambda}{\lambda} = \frac{dn_{eff}}{n_{eff}}$$

How does a DFB tune?

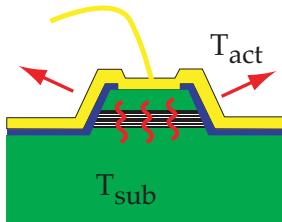

Active region heating:

$$T_{act} = T_{sub} + I \cdot U \cdot \delta \cdot R_{th} (+ I_{DC} U_{DC} \cdot R_{th})$$

$$\Delta T = T_{act} - T_{sub}$$

- If $\Delta T = 100^\circ\text{C}$ \Rightarrow 100% chance of laser-destruction (thermal stress)
- = 60°C \Rightarrow depends of mounting / laser -> dangerous
- = 30°C \Rightarrow OK

Different possibilities of thermal tuning:

- substrate temperature
- additional bias current
- pulse length (chirping)
- pulse current
- duty-cycle

Tuning by changing T_{sub} (heatsink temperature)

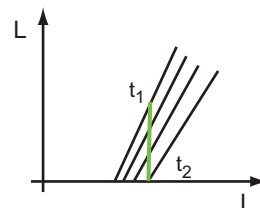
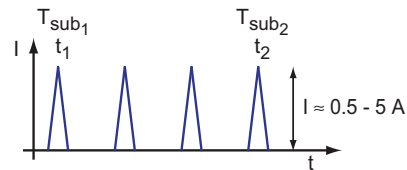
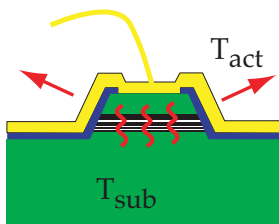

tuning coefficient :

$$\frac{1}{\lambda} \frac{\Delta \lambda}{\Delta T_{sub}} = \frac{1}{n_{eff}} \frac{\Delta n_{eff}}{\Delta T_{sub}} \approx [6 - 7] \cdot 10^{-5} \text{ K}^{-1}$$

$$\Delta T \approx 60^\circ\text{C} \Rightarrow -0.4\% \Delta v/v @ 0.01\text{Hz}$$

Tuning by DC bias-induced heating

by DC bias-induced heating

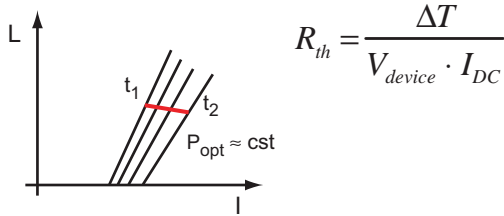
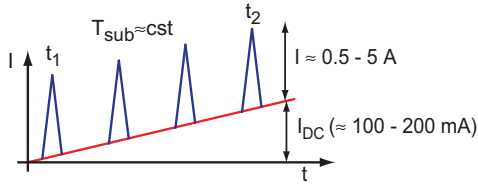

$\Delta T \approx 30^{\circ}\text{C} \Rightarrow -0.2\% \Delta v/v @ >1\text{kHz}$

by changing T_{sub}

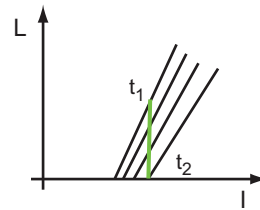
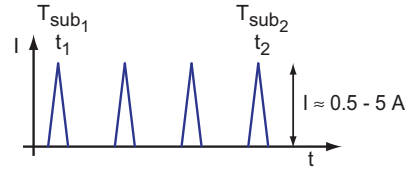

$\Delta T \approx 60^{\circ}\text{C} \Rightarrow -0.4\% \Delta v/v @ 0.01\text{Hz}$

Thermal chirping during pulse

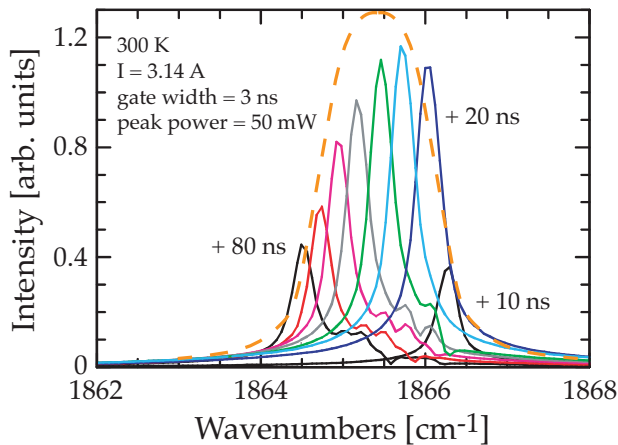

drift with time: $0.03 \text{ cm}^{-1}/\text{ns}$
(high dissipated power)

20 K temperature increase of
during a 100-ns-long pulse

Faist et al., Appl. Phys. Lett. 70, p.2670 (1997)

Pulse length dependence of linewidth

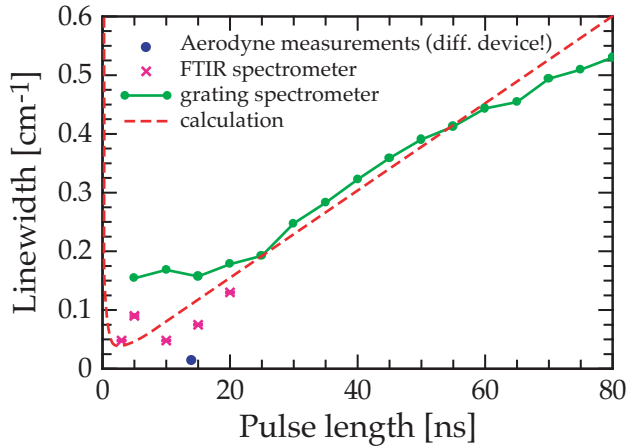

Need for a good compromise:

- too long: limited by thermal chirping
- too short: limited by the time evolution of the lasing mode

- fundamental limits
- for narrower linewidth: cw operation

Hofstetter et al., Opt. Lett. 26, p.887 (2001)

CW operation at $\lambda \approx 6.73\mu\text{m}$

LN2-CW-DFB-100-1485

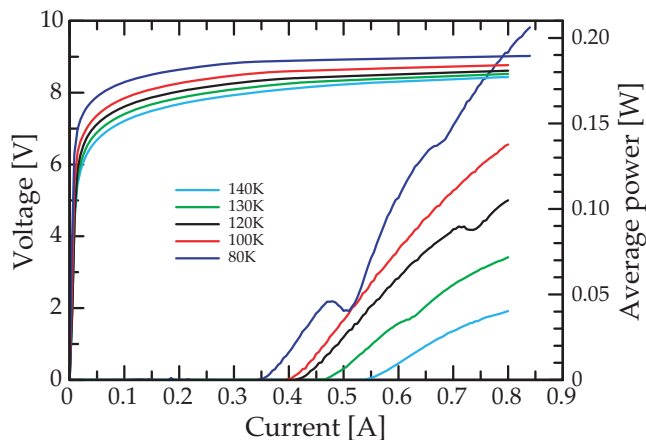

Characteristics

1.5 mm-long, 23 μm -wide laser
CW operation at $\lambda \approx 6.73\mu\text{m}$

@80 K: Average power $P = 0.2\text{ W}$
Threshold current:
 $I_{\text{th}} = 0.35\text{ A}$ ($j_{\text{th}} = 1.0\text{ kA/cm}^2$)

$I_{\text{op}} < 0.8\text{ A}$
 $U_{\text{op}} < 9\text{ V}$

CW operation at $\lambda \approx 6.73\mu\text{m}$

LN2-CW-DFB-100-1485

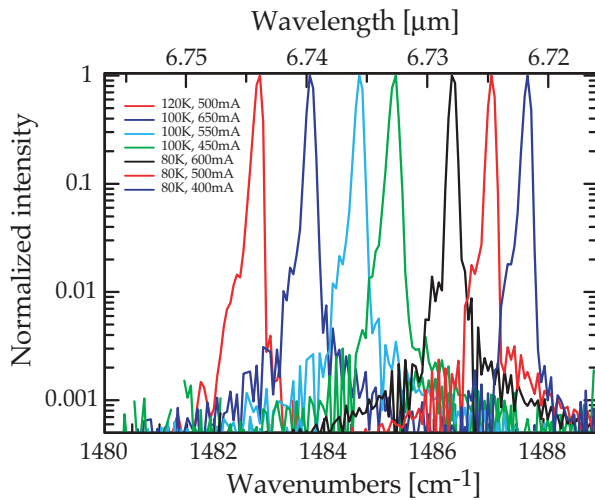

Characteristics

1.5 mm-long, 23 μm -wide laser
CW operation at $\lambda \approx 6.73\mu\text{m}$

Single-mode emission:
Side Mode Suppression Ratio > 30 dB
(limited by the resolution of the FTIR)

Tuning range:

$$\Delta\nu = 4.9\text{ cm}^{-1}\text{ at }1485\text{ cm}^{-1}\text{ (0.33\%)}$$

(1482.8 cm^{-1} (6.744 μm) at 120K to
1487.7 cm^{-1} (6.722 μm) at 80K)

CW operation at $\lambda \approx 4.60\mu\text{m}$

LN2-CW-DFB-10-2171

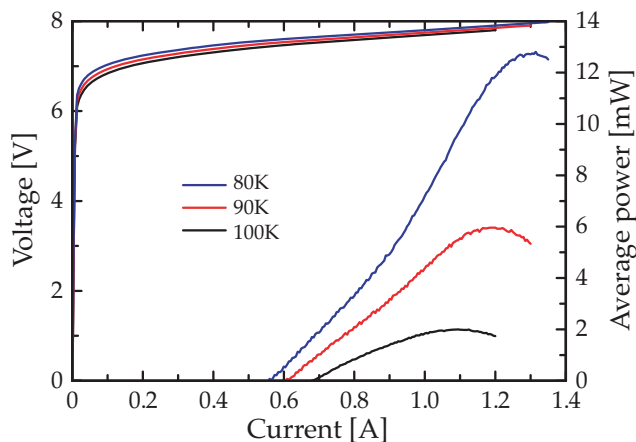

Characteristics

1.5 mm-long, 21 μm -wide laser
CW operation at $\lambda \approx 4.60\mu\text{m}$

@80 K: Average power $P = 12\text{ mW}$
Threshold current density:
 $I_{\text{th}} = 0.54\text{ A}$ ($J_{\text{th}} = 1.7\text{ kA/cm}^2$)

$$I_{\text{op}} < 1.1\text{ A}$$

$$U_{\text{op}} < 8\text{ V}$$

APPLICATIONS

Fields of applications:

Quantum cascade lasers have been proposed in a wide range of applications where powerful and reliable mid-infrared sources are needed. Examples of applications are:

Industrial process monitoring:

Contamination in semiconductor fabrication lines, food processing, brewing, combustion diagnostics.

Life sciences and medical applications

Medical diagnostics, biological contaminants.

Law enforcement

Drug or explosive detection.

Military

Chemical/biological agent detection, counter measures, covert telecommunications.

Why the mid-infrared?

Because most chemical compounds have their fundamental vibrational modes in the mid-infrared, spanning approximately the wavelength region from 3 to 15 μm , this part of the electromagnetic spectrum is very important for gas sensing and spectroscopy applications. Even more important are the two atmospheric windows at 3-5 μm and 8-12 μm . The transparency of the atmosphere in these two windows allows remote sensing and detection. As an example, here are the relative strengths of CO₂ absorption lines as a function of frequency:

Wavelength (μm)

1.432

1.602

Relative
absorption
strength

1

3.7

2.004	243
2.779	6800
4.255	69000

Approximate relative line strengths for various bands of the CO₂ gas.

Moreover, because of the long wavelength, Rayleigh scattering from dust and rain drops will be much less severe than in the visible, allowing applications such as radars, ranging, anti-collision systems, covert telecommunications and so on. As an example, Rayleigh scattering decreases by a factor 10⁴ between wavelengths of 1µm and 10µm.

Detection techniques

Direct absorption

In a direct absorption measurement, the change in intensity of a beam is recorded as the latter crosses a sampling cell where the chemical to be detected is contained. This measurement technique has the advantage of simplicity. In a version of this technique, the light interacts with the chemical through the evanescent field of a waveguide or an optical fiber.

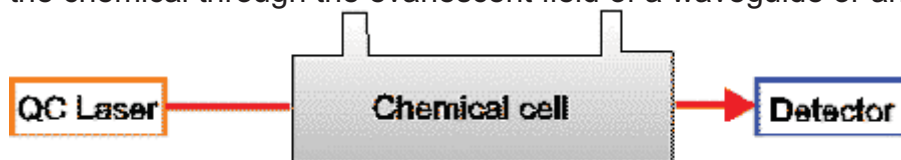

Some examples of use a direct absorption technique:

- [A. Müller et al. 1999 \(PDF 1187kB\)](#)
- B. Lendl et al.

Frequency modulation technique (TILDAS)

In this technique, the frequency of the laser is modulated sinusoidally so as to be periodically in and out of the absorption peak of the chemical to be detected. The absorption in the cell will convert this FM modulation into an AM modulation, which is then detected usually by a lock-in technique.

TILDAS DETECTION TECHNIQUE

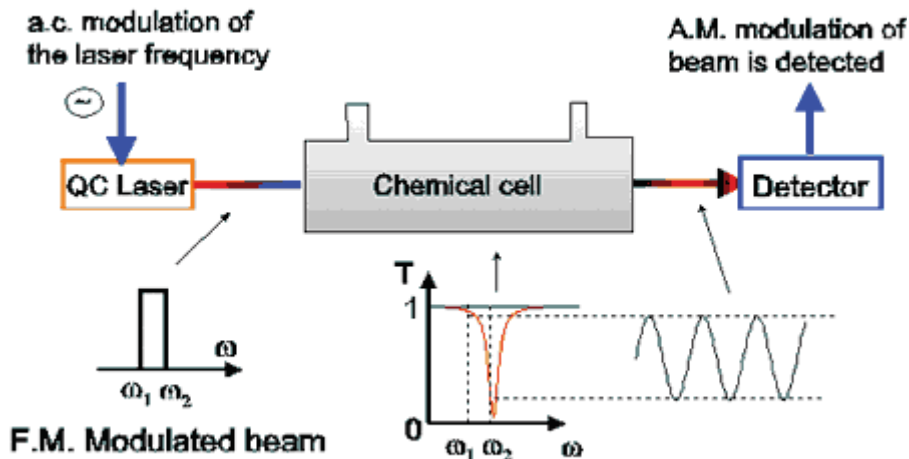

The absorption converts F.M. in A.M modulation

The advantage of the TILDAS technique is mainly its sensitivity. First of all, under good modulation condition, an a.c. signal on the detector is only present when there is absorption in the chemical cell. Secondly, this signal discriminates efficiently against slowly varying absorption backgrounds. For this reason, this technique will usually work well for narrow absorption lines, requiring also a monomode emission from the laser itself. This technique has already been successfully applied with Distributed Feedback Quantum Cascade Laser (DFB-QCL). Some examples in the literature include:

- [E. Whittaker et al, Optics Letters 1998 \(PDF 229kB\)](#)
- F. Tittel et al., accepted for publication in Optics Letters.

Photoacoustic detection

In the photoacoustic technique, the optical beam is periodically modulated in amplitude before illuminating the cell containing the absorbing chemical. The expansion generated by the periodic heating of the chemical creates an acoustic wave, which is detected by a microphone. The two very important advantages of photoacoustic detection are

- a signal is detected only in the presence of absorption from the molecule
- no mid-ir detectors are needed.

For these reasons, photoacoustic detection has the potential of being both cheap and very sensitive. However, ultimate sensitivity is usually limited by the optical power of the source.

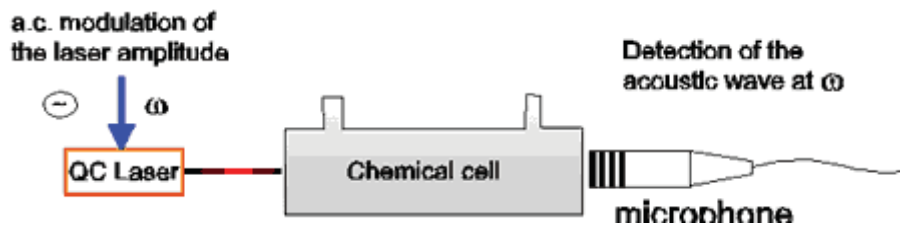

Photoacoustic detection has already been used successfully with unipolar laser, see

- Paldus et al., Optics Letters ...

Customers

Our list of customers includes:

[Jet Propulsion Laboratory](#) (USA), [Vienna University of Technology](#) (Austria), [Fraunhofer Institute](#) (Germany), [Georgia Institute of technology](#) (USA), [ETHZ](#) (Switzerland), [Physical Sciences Inc.](#) (USA): [first QCL based product](#), [Aerodyne](#) (USA), Scuola Normale de Pisa (Italy), Orbisphere (Switzerland).

TECHNOLOGY

General device characteristics

How do I drive the device?

As for any semiconductor laser, the performance of the device depends on the temperature. In general, unipolar lasers need (negative) operating voltage around 10 V with (peak-) currents between 1 and 5 A, depending on the temperature and the device. Around room temperature, that is the temperature range (-40..+70 °C) that can be reached by Peltier elements, unipolar lasers operate only in pulsed mode because of the large amount of heat dissipated in the device. In general, pulse length around 100 ns is suitable for Fabry Pérot devices. Alpes Lasers sells [electronic drivers](#) dedicated to unipolar lasers.

Electrical behavior and I-V characteristics

Quantum cascade lasers exhibit I-V curves that are diode like characteristics for short wavelength devices ($\lambda = 5 \mu\text{m}$) to almost ohmic behavior for $\lambda = 11 \mu\text{m}$. In any case the differential resistance at threshold is a few ohms. Long wavelength devices often exhibit a maximum current above which, if driven harder, the voltage increases abruptly while the optical power drops to zero. This process, which occurs only in unipolar lasers, is usually non-destructive and reversible if the device is not driven too hard above its maximum current.

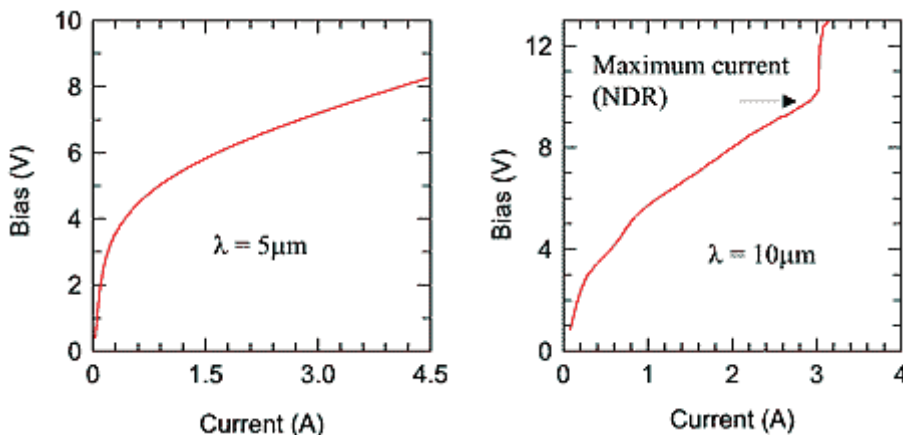

Room temperature I-V curves of unipolar lasers (measured in pulsed mode). The device operating at $\lambda = 10 \mu\text{m}$ has a maximum operation current (because of the appearance of Negative Differential Resistance or NDR) of 3.2 A.

Electrical model:

In a simplified way, the device can be modeled, for electronic purpose, by a combination of two resistors and two capacitors. As shown by the above I-V curves, R1 increases from 10 to 20 Ohms at low biases to 1-3 Ohms at the operating point. C1 is a 100-pF capacitor (essentially bias independent) between the cathode and the anode coming from the bonding pads. C2 depends on your mounting of the laser typically in the Laboratory Laser Housing, C1<100 pF

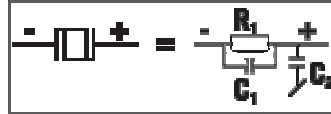

Temperature dependence of the laser characteristics:

The threshold current and slope efficiency are temperature dependent, although this dependence is much weaker than the one observed in interband devices at similar wavelengths. Shown below are a set of power versus current curves taken from a device $\lambda = 10 \mu\text{m}$ at various temperatures. In general, the device has a maximum operation temperature, which, depending on the design and wavelength, can be between 300K to a maximum of 400K. As maximum power and sometimes slope efficiencies both increase with decreasing temperature, it is usually advisable to cool the device with a Peltier element. Alpes Lasers sells a [special Peltier cooled housing](#) dedicated to driving unipolar lasers. Peak power between 20 and 100 mW, which is equal to average powers between 2 and 10 mW, are obtained typically.

High temperature pulsed operation

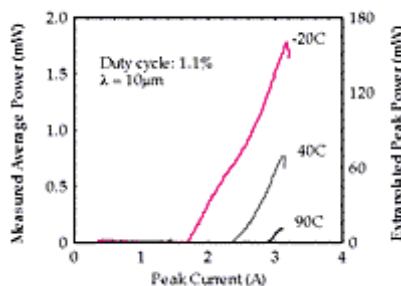

Extrapolated maximum operation temperature 105C

Peak and average power (at a duty cycle of 1.5%) for a unipolar laser as a function of temperature.

Peltier-cooled Fabry-perot QC laser

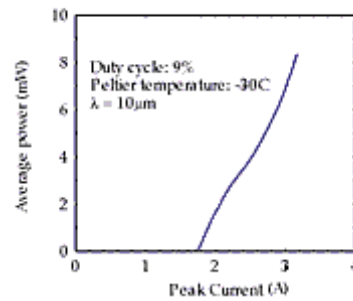

High duty cycle operation of a unipolar laser

Typically, because of excess heat due to the driving current, unipolar lasers must be driven by current bursts with typically 10 ns rise time and a pulse-length of 100 ns. Some unipolar lasers may also operate in continuous wave (c.w.) at cryogenic temperatures, with a maximum operating temperature of 50 to 100 K depending on the design.

Alpes Lasers specify c.w. operation on special request.

Spectral characteristics

Under pulsed operation, the spectra of these lasers are multimode, the spectral width of the emission being of about one to fifty nanometer ($1\text{-}30\text{ cm}^{-1}$, typically 10 cm^{-1}) depending on the device design and operating point. Although it is not a property common to all unipolar laser designs, our long-wavelength devices will blue shift with increasing current, as shown on the figure below.

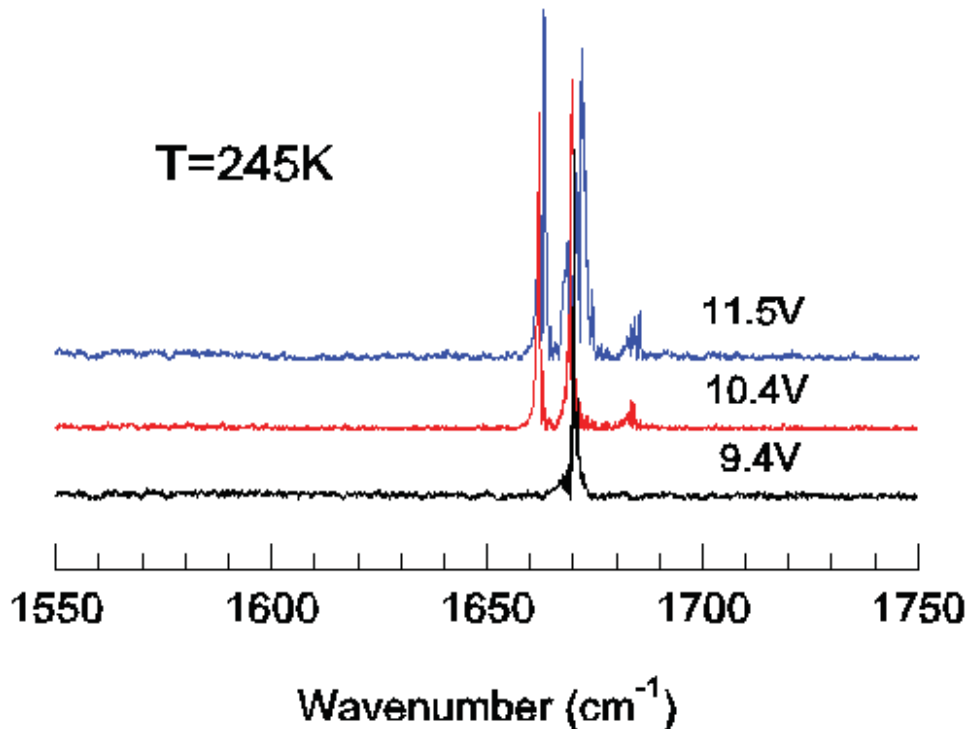
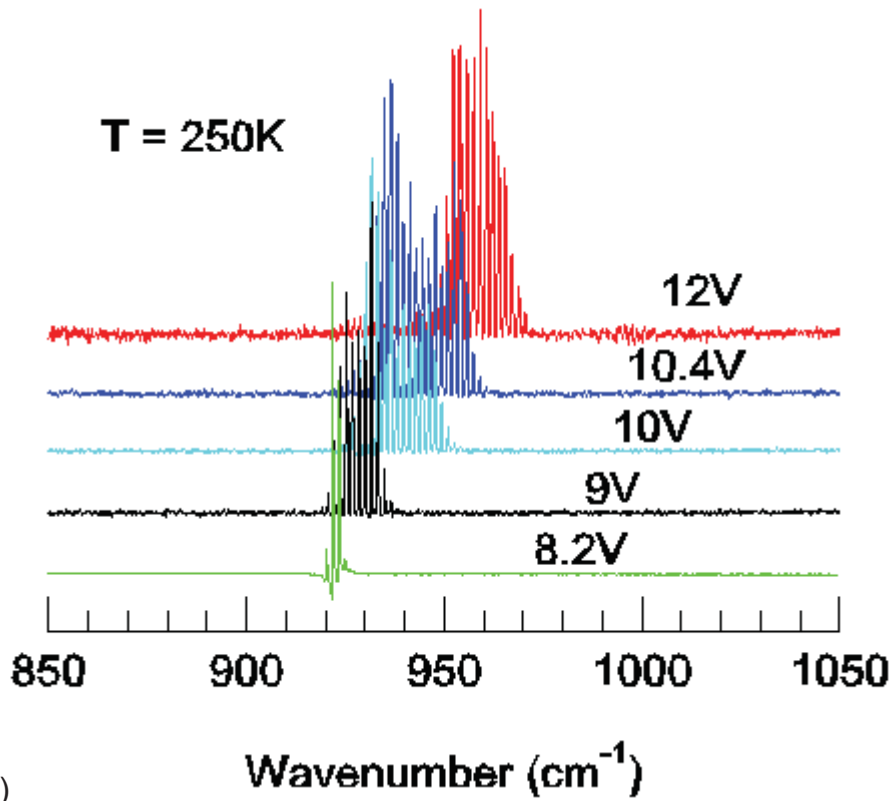

- a) spectra of a long wavelength laser based on a diagonal transition
 b) spectrum of a short wavelength laser based on a vertical transition

Electrical tuning

By driving the device with two different electrodes, wavelength and output power can be independently adjusted. Tuning ranges as large as 40 cm^{-1} at a peak power of 5 mW and a temperature of $-10 \text{ }^\circ\text{C}$ have been obtained by Alpes Lasers.

See [literature](#) for more details on this technique.

Distributed Feedback Laser (DFB)

In a Distributed Feedback Laser, a grating is etched into the active region to force the operation of the laser at very specific wavelength determined by the grating periodicity. As a consequence, the laser is single frequency which may be adjusted slightly by changing the temperature of the active region with a tuning rate of $1/n$ $Dn/DT = 6 \times 10^{-5} \text{ K}^{-1}$.

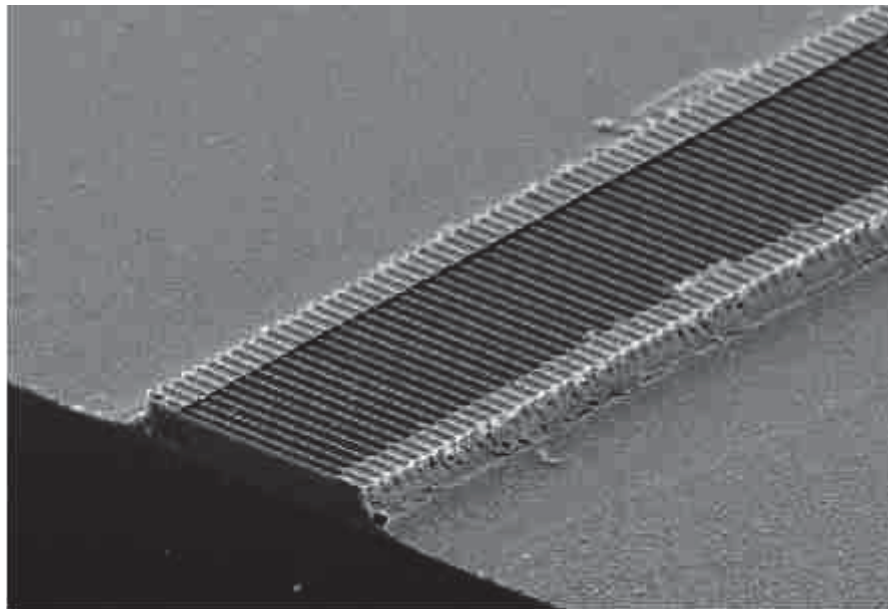

Scanning Micrograph image of a Distributed Feedback Unipolar Laser (DFB-UL).
The grating selecting the emission wavelength is well visible on the surface.

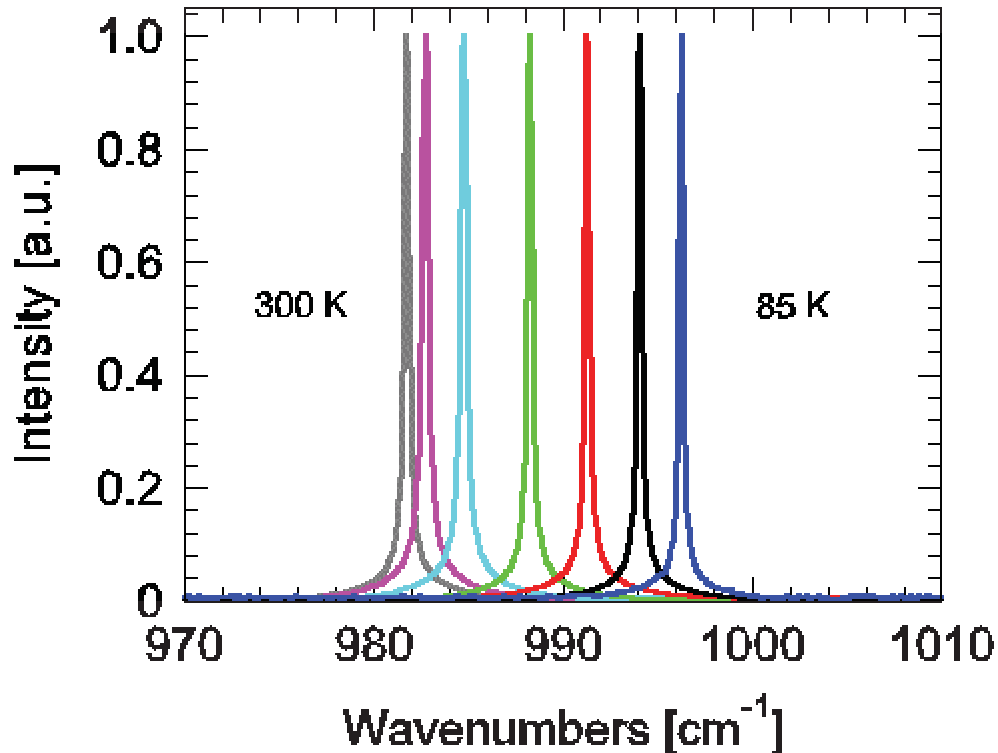

Emission spectra versus temperature for a DFB-UL. The device is driven at its maximum current.

It must be stressed that because of this tuning effect, when operated in pulsed mode close to room temperature, the linewidth of emission is a strong function of quality of electronics driving the laser. The latter should optimally deliver short pulses (best 1-10 ns to obtain the narrowest lines) with an excellent amplitude stability. The laser will drift at an approximate rate of a fraction of Kelvin per nanosecond during the pulse [\[see literature\]](#).

Beam Properties

Polarization

Because the intersubband transition exhibit a quantum mechanical selection rule, the emission from a unipolar laser is always polarized linearly with the electric field perpendicular to the layers (and the copper sub mount).

Beam divergence

The unipolar laser is designed around a tightly confined waveguide. For this reason, the beam diffracts strongly at the output facet and has a (full) divergence angle of about 60 degrees perpendicular to the layer and 40 degrees parallel to the layers

(see figures below). A $f\#1$ optics will typically collect about 70% of the emitted output power. Be careful that the collected output power will decrease with the square of the f-number of the collection optics. The mode is usually very close to a Gaussian 0,0 mode.

Typical beam profile of an uncollimated QCL.

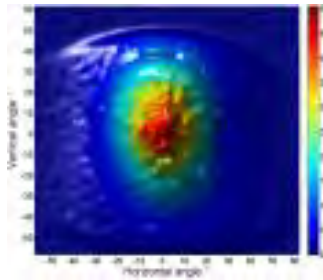

Typical beam profile of an collimated QCL.

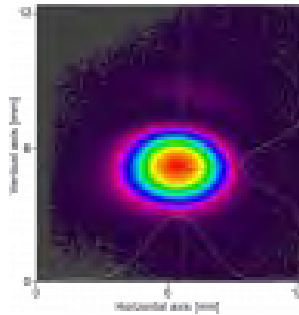

REVIEW PAPERS

High Performance, low dissipation QCLs...

High Performance, low dissipation QCLs across the mid-IR range

Alfredo Bismuto • Stéphane Blaser • Romain Terazzi • Tobias Gresch • Antoine Muller

Optics Express
Vol. 23 no 5 p. 5477 (2014)

[» view PDF](#)

Surface-emitting THz sources based on...

***Surface-emitting THz sources based on difference-frequency generation in mid-infrared quantum cascade lasers
(Proceedings Paper)***

M. Geiser • C. Pflügl • A. Belyanin • Q. J. Wang • N. Yu • M. A. Belkin • T. Edamura • H. Kan • M. Fischer • A. Wittmann • J. Faist • Federico Capasso

Novel In-Plane Semiconductor Lasers IX (Proceedings Volume) Proceedings of SPIE
Volume: 7616. (2010)

Broadband THz lasing from a photon-phonon QC structure

Broadband THz lasing from a photon-phonon quantum cascade structure

G. Scalari • M. I. Amanti • C. Walther • R. Terazzi • M. Beck • J. Faist

Opt. Express 18, 8043-8052 (2010)

[» link](#)

Electrically tunable, high performance QCL

Electrically tunable, high performance quantum cascade laser

A. Bismuto • R. Terazzi • M. Beck • Jerome Faist

Applied Physics Letters, Apr 2010, Volume 96, Issue 14

The QCL: Ready for take-off

The quantum cascade laser: Ready for take-off

Antoine Müller • Jérôme Faist

Nature Photonics 4, 291 (2010)

Gas detection with QCLs

Gas detection with quantum cascade lasers: An adapted photoacoustic sensor based on Helmholtz resonance

S. Barbieri • J.-P. Pellaux • E. Studemann • D. Rosser

Review of Scientific Instruments: V73, 6, (2002)

[» view PDF](#)

QCLs based on a bound-to-continuum transition

Quantum-cascade lasers based on a bound-to-continuum transition

J. Faist • M. Beck • T. Aellen • E. Gini

Applied Physics Letters: V78, 2, (2001)

[» view PDF](#)

Novel QCL Based Measurements of Chemicals...

Novel Quantum Cascade Laser Based Measurements of Chemicals in Liquid and Gases with 50 Fold Improved Signal to Noise Ratio

Proceedings Sensors Expo: Antoine Müller • M. Beck • J. Faist • R. Schindler • H. Ehmoser • B. Lendl • J.-P. Pellaux

Cleveland (USA)

[» view PDF](#)

Electrically tunable room-temperature QCLs

Electrically tunable room-temperature quantum-cascade lasers

A. Müller • Mattias Beck • Jérôme Faist • Ursula Oesterle • Marc Illegems

Applied Physics Letters: V75, 11, (1999)

[» view PDF](#)

Demonstration of High-performance 10.16mm QC...

Demonstration of High-performance 10.16mm quantum cascade distributed feedback laser fabricated without epitaxial regrowth

D. Hofstetter • J. Faist • M. Beck • A. Müller • U. Oesterle

Applied Physics Letters: V75, 5, (1999)

[» view PDF](#)



Boston Electronics are exclusive North American Technical Sales Agents for Tunable Infrared Quantum Cascade Lasers from Alpes Lasers SA of Switzerland. Alpes Lasers was the first QCL company in the world and offers a variety of QCLs which differ in semiconductor architecture and intended use. This sheet is intended to help you understand the available options and make your choice quicker and easier.

Spectroscopy Grade, Tunable	DFBs	Extremely narrow linewidths tune over a narrow spectral range with high resolution (usually < 1 cm ⁻¹) with milliwatts of power for Beer's Law measurements.
	Extended tuning range DFBs	-XT and -ET series devices with embedded chip features to allow rapid tuning over > 5 cm ⁻¹ or wider - tuning (to >2% of center wavelength)
	External Cavities	Extended tuning up to 300 cm ⁻¹ with linewidths and of 1 cm ⁻¹ and pulsed operation at mW average power levels
	Frequency Combs	Simultaneous measurement of high-resolution spectra over > 50 cm ⁻¹ enabled by this concept
Compact IR Sources at arbitrary wavelengths	Fabry Perots	Emission bands (gain profiles) from 50 to > 300 cm ⁻¹ . Power levels from 10s of mW to >1.5W average or >20W peak. Applications include chips for external cavities, IR communications and IRCM.